

Features

- Diffused Junction
- Low Forward Voltage Drop
- High Current Capability
- High Reliability
- High Surge Current Capability

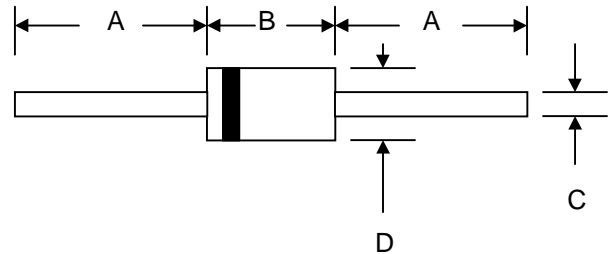

Mechanical Data

- Case: Molded Plastic
- Terminals: Plated Leads Solderable per MIL-STD-202, Method 208
- Polarity: Cathode Band
- Weight: 1.2 grams (approx.)
- Mounting Position: Any
- Marking: Type Number
- Epoxy: UL 94V-O rate flame retardant

| DO-201AD | | |
|----------------------|------|------|
| Dim | Min | Max |
| A | 25.4 | — |
| B | 8.50 | 9.50 |
| C | 1.20 | 1.30 |
| D | 5.0 | 5.60 |
| All Dimensions in mm | | |

Maximum Ratings and Electrical Characteristics @ $T_A=25^\circ\text{C}$ unless otherwise specified

Single Phase, half wave, 60Hz, resistive or inductive load.
For capacitive load, derate current by 20%.

| Characteristic | Symbol | SFR301 | SFR302 | SFR303 | SFR304 | SFR305 | SFR306 | SFR307 | Unit |
|--|--------------|-------------|--------|--------|--------|--------|--------|--------|------------------|
| Peak Repetitive Reverse Voltage | V_{RRM} | | | | | | | | |
| Working Peak Reverse Voltage | V_{RWM} | 50 | 100 | 200 | 400 | 600 | 800 | 1000 | V |
| DC Blocking Voltage | V_R | | | | | | | | |
| RMS Reverse Voltage | $V_{R(RMS)}$ | 35 | 70 | 140 | 280 | 420 | 560 | 700 | V |
| Average Rectified Output Current (Note 1) @ $T_A = 55^\circ\text{C}$ | I_O | 3.0 | | | | | | | A |
| Non-Repetitive Peak Forward Surge Current 8.3ms Single half sine-wave superimposed on rated load (JEDEC Method) | I_{FSM} | 150 | | | | | | | A |
| Forward Voltage @ $I_F = 3.0\text{A}$ | V_{FM} | 1.2 | | | | | | | V |
| Peak Reverse Current @ $T_A = 25^\circ\text{C}$ At Rated DC Blocking Voltage @ $T_A = 100^\circ\text{C}$ | I_{RM} | 5.0 100 | | | | | | | μA |
| Reverse Recovery Time (Note 2) | t_{rr} | 120 | | | | 200 | 350 | | nS |
| Typical Junction Capacitance (Note 3) | C_j | 60 | | | | | | | pF |
| Operating Temperature Range | T_j | -65 to +125 | | | | | | | $^\circ\text{C}$ |
| Storage Temperature Range | T_{STG} | -65 to +150 | | | | | | | $^\circ\text{C}$ |

*Glass passivated forms are available upon request

Note: 1. Leads maintained at ambient temperature at a distance of 9.5mm from the case

2. Measured with $I_F = 0.5\text{A}$, $I_R = 1.0\text{A}$, $IRR = 0.25\text{A}$. See figure 5.

3. Measured at 1.0 MHz and applied reverse voltage of 4.0V D.C.

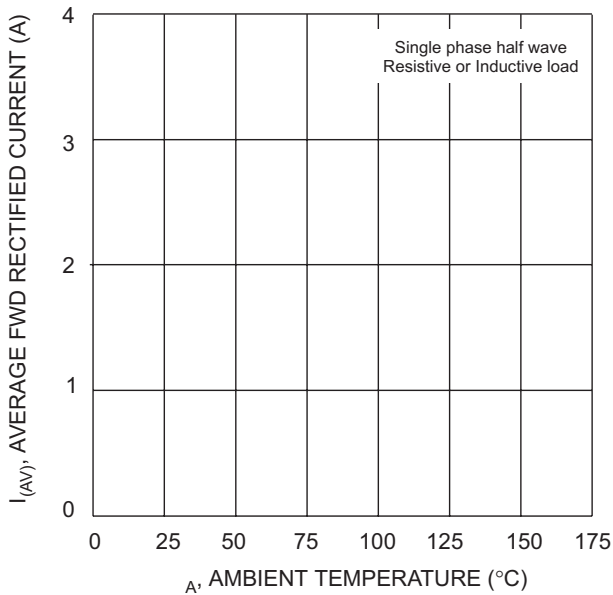

Fig. 1 Forward Derating Curve

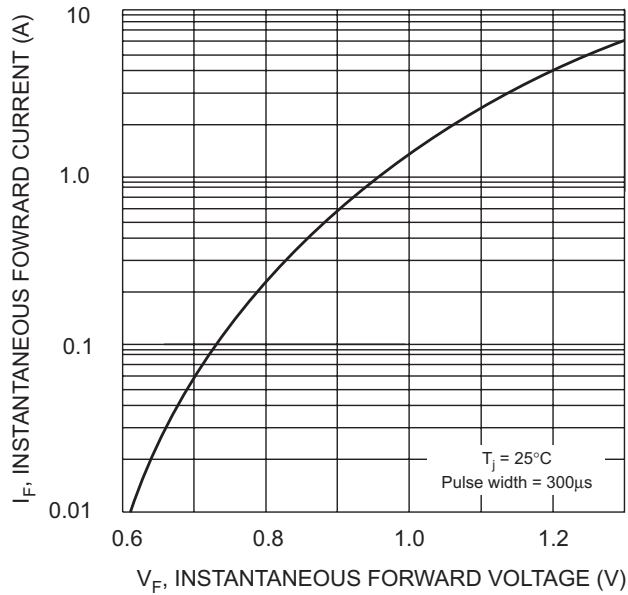

Fig. 2 Typical Forward Characteristics

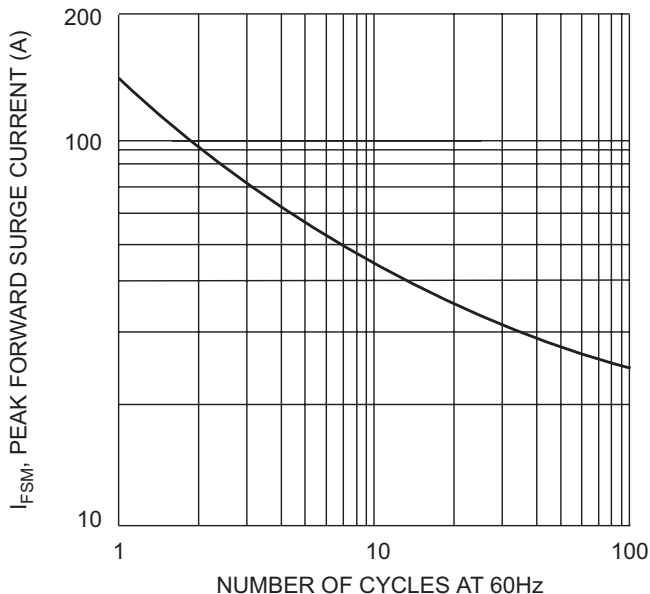

Fig. 3 Peak Forward Surge Current

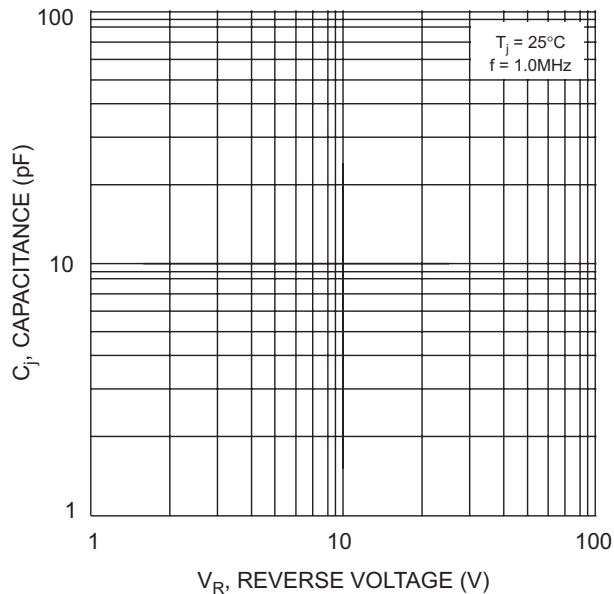
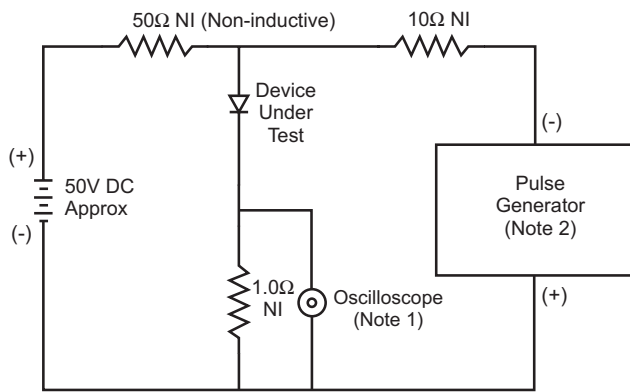
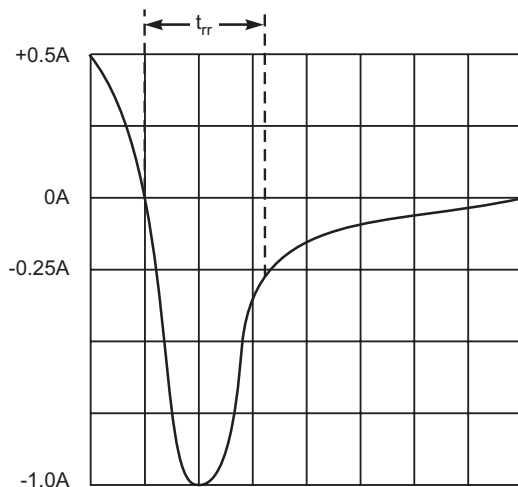

Fig. 4 Typical Junction Capacitance



- Notes:
1. Rise Time = 7.0ns max. Input Impedance = 1.0MΩ, 22pF.
 2. Rise Time = 10ns max. Input Impedance = 50Ω.



Set time base for 5/10ns/cm

Fig. 5 Reverse Recovery Time Characteristic and Test Circuit

ORDERING INFORMATION

| Product No.◆ | Package Type | Shipping Quantity |
|------------------|--------------|-------------------|
| SFR301-T3 | DO-201AD | 1200/Tape & Reel |
| SFR301-TB | DO-201AD | 1200/Tape & Box |
| SFR301 | DO-201AD | 500 Units/Box |
| SFR302-T3 | DO-201AD | 1200/Tape & Reel |
| SFR302-TB | DO-201AD | 1200/Tape & Box |
| SFR302 | DO-201AD | 500 Units/Box |
| SFR303-T3 | DO-201AD | 1200/Tape & Reel |
| SFR303-TB | DO-201AD | 1200/Tape & Box |
| SFR303 | DO-201AD | 500 Units/Box |
| SFR304-T3 | DO-201AD | 1200/Tape & Reel |
| SFR304-TB | DO-201AD | 1200/Tape & Box |
| SFR304 | DO-201AD | 500 Units/Box |
| SFR305-T3 | DO-201AD | 1200/Tape & Reel |
| SFR305-TB | DO-201AD | 1200/Tape & Box |
| SFR305 | DO-201AD | 500 Units/Box |
| SFR306-T3 | DO-201AD | 1200/Tape & Reel |
| SFR306-TB | DO-201AD | 1200/Tape & Box |
| SFR306 | DO-201AD | 500 Units/Box |
| SFR307-T3 | DO-201AD | 1200/Tape & Reel |
| SFR307-TB | DO-201AD | 1200/Tape & Box |
| SFR307 | DO-201AD | 500 Units/Box |

Products listed in **bold** are WTE **Preferred** devices.

◆T3 suffix refers to a 13" reel. TB suffix refers to Ammo Pack.

Shipping quantity given is for minimum packing quantity only. For minimum order quantity, please consult the Sales Department.

Won-Top Electronics Co., Ltd (WTE) has checked all information carefully and believes it to be correct and accurate. However, WTE cannot assume any responsibility for inaccuracies. Furthermore, this information does not give the purchaser of semiconductor devices any license under patent rights to manufacturer. WTE reserves the right to change any or all information herein without further notice.

WARNING: DO NOT USE IN LIFE SUPPORT EQUIPMENT. WTE power semiconductor products are not authorized for use as critical components in life support devices or systems without the express written approval.

Won-Top Electronics Co., Ltd.

No. 44 Yu Kang North 3rd Road, Chine Chen Dist., Kaohsiung, Taiwan

Phone: 886-7-822-5408 or 886-7-822-5410

Fax: 886-7-822-5417

Email: sales@wontop.com

Internet: http://www.wontop.com

We power your everyday.