

# LCD Module Specification

First Edition

June 26, 1998

Final Revision

\*\*\*\*\*

Approved by Production Div.

Checked by Quality Assurance Div.

Checked by Design Engineering Div.

Prepared by Production Div.

Type No. **DMC 2 0 2 1 5 A**

## Table of Contents

1. General Specifications .....	2
2. Electrical Specifications.....	3
3. Optical Specifications .....	6
4. I/O Terminal.....	8
5. Test.....	10
6. Appearance Standards.....	11
7. Code System of Production Lot .....	14
8. Type Number .....	14
9. Applying Precautions .....	14
10. Handling Precautions .....	15

## Revision History

Rev.	Date	Page	Comment



## 1. General Specifications

Operating Temp.	:	min. 0°C ~ max. 50°C
Storage Temp.	:	min. -20°C ~ max. 70°C
Display Format	:	20 characters × 2 lines
Display Fonts	:	5 × 8 dots ( 1 character )
Viewing Area	:	83.0 (W) × 18.6 (H) mm
Outline Dimensions	:	116.0 (W) × 44.0 (H) × (11) (D) mm
Weight	:	45g max.
LCD Type	:	FRD-7057 ( TN / Clear -mode / Reflective )
Viewing Angle	:	6:00
Backlight	:	None
Drawings	:	Dimensional Outline    UE-30230B

## 2. Electrical Specifications

### 2.1. Absolute Maximum Ratings

V<sub>SS</sub>=0V

Parameter	Symbol	Conditions	Min.	Max.	Units
Supply Voltage (Logic)	V <sub>CC</sub> -V <sub>SS</sub>	—	-0.3	7.0	V
Supply Voltage (LCD Drive)	V <sub>CC</sub> -V <sub>EE</sub>	—	0	13.0	V
Input Voltage	V <sub>I</sub>	—	-0.3	V <sub>CC</sub> +0.3	V

### 2.2. DC Characteristics

T<sub>a</sub>=25°C, V<sub>SS</sub>=0V

Parameter	Symbol	Conditions	Min.	Typ.	Max.	Units
Supply Voltage (Logic)	V <sub>CC</sub> -V <sub>SS</sub>	—	4.5	—	5.5	V
Supply Voltage (LCD Drive)	V <sub>CC</sub> -V <sub>EE</sub>	Shown in 3.1				V
High Level Input Voltage	V <sub>IH</sub>	V <sub>CC</sub> =5.0V ± 10%	2.2	—	V <sub>CC</sub>	V
Low Level Input Voltage	V <sub>IL</sub>	V <sub>CC</sub> =5.0V ± 10%	0	—	0.6	V
High Level Output Voltage	V <sub>OH</sub>	I <sub>OH</sub> =-0.205mA	2.4	—	V <sub>CC</sub>	V
Low Level Output Voltage	V <sub>OL</sub>	I <sub>OL</sub> =1.2mA	0	—	0.4	V
Supply Current	I <sub>CC</sub>	V <sub>CC</sub> -V <sub>SS</sub> =5.0V	—	1.5	3.0	mA

### 2.3.AC Characteristics

$V_{CC}=5.0V \pm 10\%$

Parameter	Symbol	Conditions	Min.	Max.	Units
Enable Cycle Time	$t_{CYC}$	Fig.1, 2	500	—	ns
Enable Pulse Width	$P_{WEH}$	Fig.1, 2	230	—	ns
Enable Rise/Fall Time	$t_{Er}, t_{Ef}$	Fig.1, 2	—	20	ns
Address Setup Time	$t_{AS}$	Fig.1, 2	40	—	ns
Address Hold Time	$t_{AH}$	Fig.1, 2	10	—	ns
Write Data Setup Time	$t_{DSW}$	Fig.1	80	—	ns
Write Data Hold Time	$t_{DHW}$	Fig.1	10	—	ns
Read Data Delay Time	$t_{DDR}$	Fig.2	—	160	ns
Read Data Hold Time	$t_{DHR}$	Fig.2	5	—	ns



Fig.1 Write Operation Timing



Fig.2 Read Operation Timing

## 2.4. Power Supply ON/OFF Sequence

### 2.4.1. ON Sequence

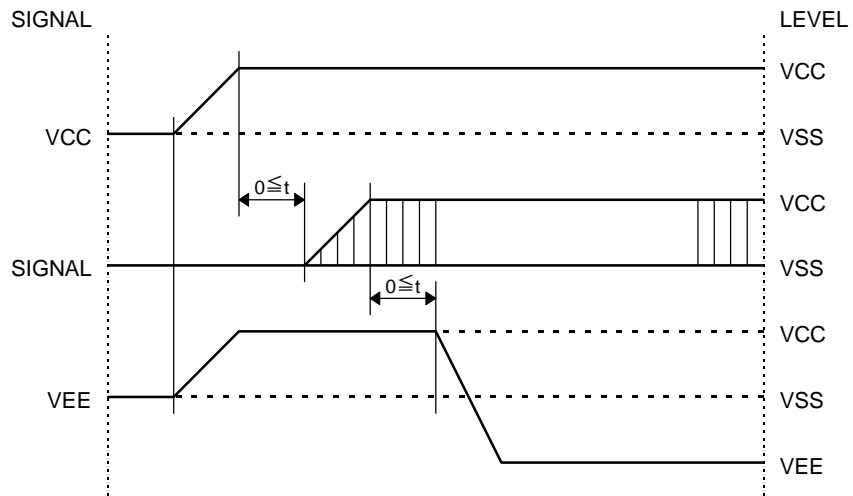

### 2.4.2. OFF Sequence

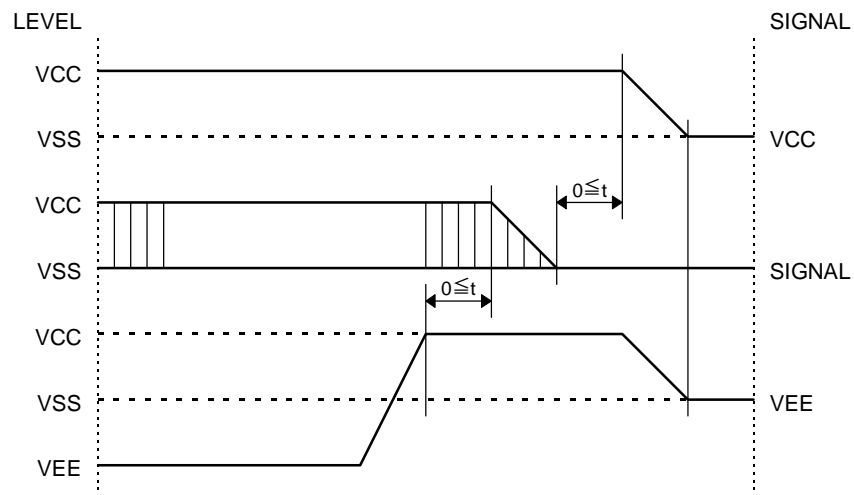

Please maintain the above sequence when turning on and off the power supply of the module.  
If V<sub>EE</sub> is supplied to the module while internal alternate signal for LCD driving (M) is unstable, DC component will be supplied to the LCD panel. This may cause damage the LCD module.

### 3. Optical Specifications

#### 3.1. LCD Driving Voltage

Parameter	Symbol	Conditions	Min.	Typ.	Max.	Units
Recommended LCD Driving Voltage Note 1	$V_{CC}-V_{EE}$	$T_a=0^{\circ}\text{C}$	—	—	5.0	V
		$T_a=25^{\circ}\text{C}$	4.0	4.3	4.6	V
		$T_a=50^{\circ}\text{C}$	3.5	—	—	V

Note 1 : Voltage (Applied actual waveform to LCD Module) for the best contrast. The range of minimum and maximum shows tolerance of the operating voltage. The specified contrast ratio and response time are not guaranteed over the entire range.

#### 3.2. Optical Characteristics

$T_a=25^{\circ}\text{C}$ , 1/16 Duty, 1/5 Bias,  $V_D=4.3\text{V}$  (Note 4),  $\theta = 20^{\circ}$ ,  $\phi = 270^{\circ}$

Parameter	Symbol	Conditions	Min.	Typ.	Max.	Units
Contrast Ratio Note 1	CR	$\theta = 20^{\circ}$ , $\phi = 270^{\circ}$	—	3.5	—	
Viewing Angle		Shown in 3.3				
Response Time	Rise Note 2	$T_{ON}$	—	180	270	ms
	Decay Note 3	$T_{OFF}$	—	130	200	ms

Note 1 : Contrast ratio is defined as follows.

$$CR = L_{OFF} / L_{ON}$$

$L_{ON}$  : Luminance of the ON segments

$L_{OFF}$  : Luminance of the OFF segments

Note 2 : The time that the luminance level reaches 90% of the saturation level from 0% when ON signal is applied.

Note 3 : The time that the luminance level reaches 10% of the saturation level from 100% when OFF signal is applied.

Note 4 : Definition of Driving Voltage  $V_D$

Assuming that the typical driving waveforms shown below are applied to the LCD Panel at 1/A Duty - 1/B Bias ( A : Duty Number, B : Bias Number ). Driving voltage  $V_D$  is defined as follows.

$$V_D = (V_{th1} + V_{th2}) / 2$$

$V_{th1}$  : The voltage  $V_{O-P}$  that should provide 50% of the saturation level in the luminance measured at  $\theta = 10^{\circ}$ ,  $\phi = 270^{\circ}$  on the segment which the ON signal is applied to.

$V_{th2}$  : The voltage  $V_{O-P}$  that should provide 26% of the saturation level in the luminance measured at  $\theta = 40^{\circ}$ ,  $\phi = 270^{\circ}$  on the segment which the OFF signal is applied to.

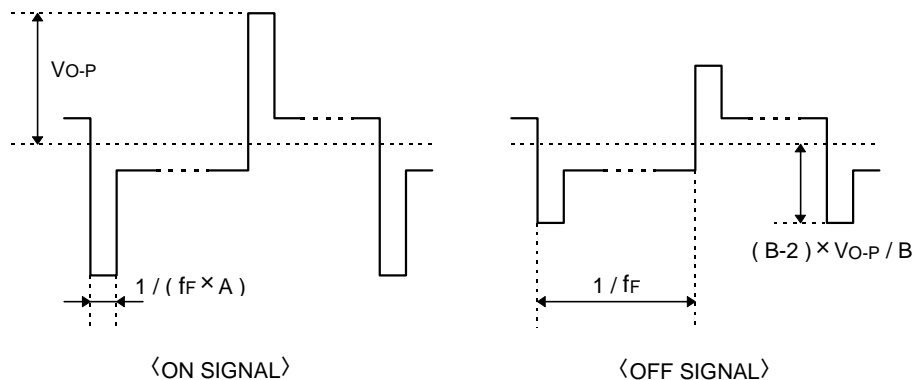

### 3.3. Definition of Viewing Angle and Optimum Viewing Area

- Point ● shows the point where contrast ratio is measured. :  $\theta = 20^\circ$ ,  $\phi = 270^\circ$
- Driving condition : 1/16 Duty, 1/5 Bias,  $V_D=4.3V$ ,  $f_F=84.4Hz$

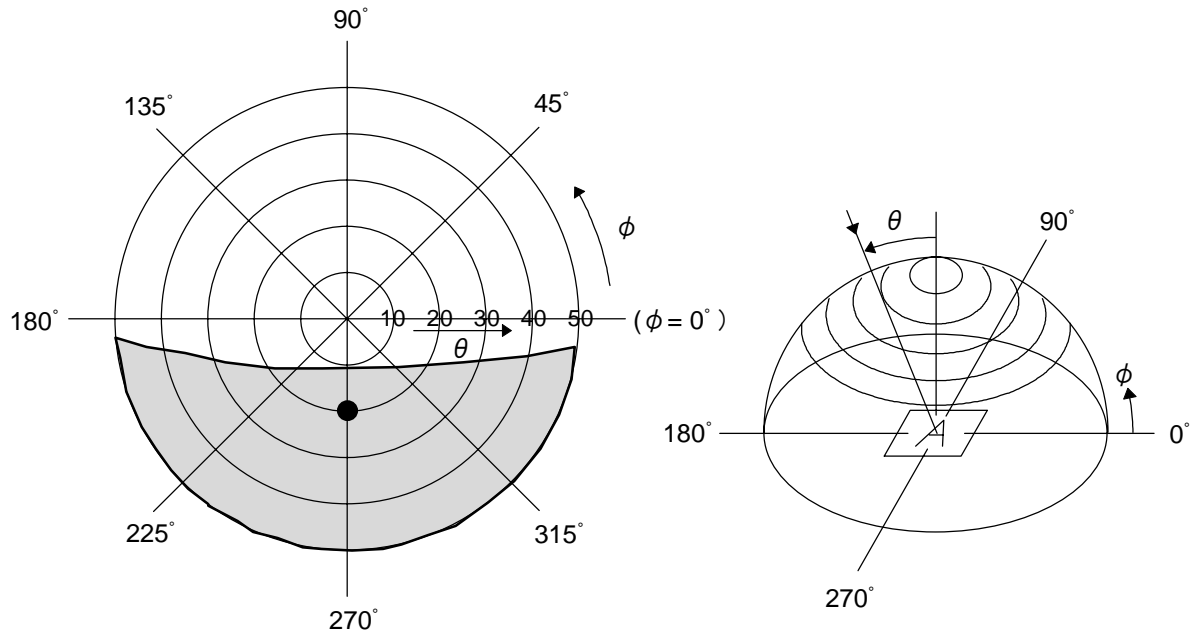

• Area  shows typ.  $CR \geq 2$

### 3.4. System Block Diagram

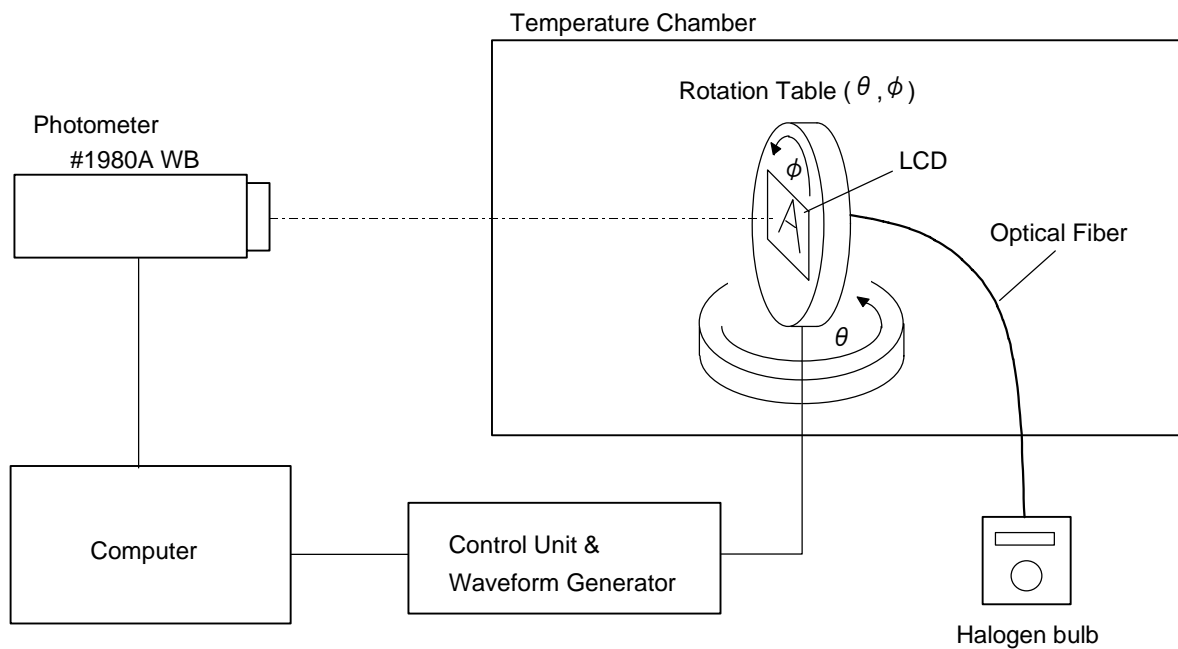

## 4. I/O Terminal

### 4.1. Pin Assignment

#### CN1

No.	Symbol	Level	Function
1	V <sub>SS</sub>	—	Power Supply (0V, GND)
2	V <sub>CC</sub>	—	Power Supply for Logic
3	V <sub>EE</sub>	—	Power Supply for LCD Drive
4	RS	H / L	Register Select Signal
5	R/W	H / L	Read/Write Select Signal H : Read L : Write
6	E	H, H→L	Enable Signal (No pull-up Resister)
7	DB0	H / L	Data Bus Line / Non-connection at 4-bit operation
8	DB1	H / L	Data Bus Line / Non-connection at 4-bit operation
9	DB2	H / L	Data Bus Line / Non-connection at 4-bit operation
10	DB3	H / L	Data Bus Line / Non-connection at 4-bit operation
11	DB4	H / L	Data Bus Line
12	DB5	H / L	Data Bus Line
13	DB6	H / L	Data Bus Line
14	DB7	H / L	Data Bus Line

### 4.2. Example of Power Supply

It is recommended to apply a potentiometer for the contrast adjust due to the tolerance of the driving voltage and its temperature dependence.

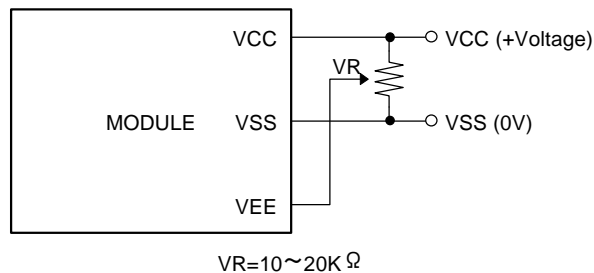



### 4.3. Block Diagram

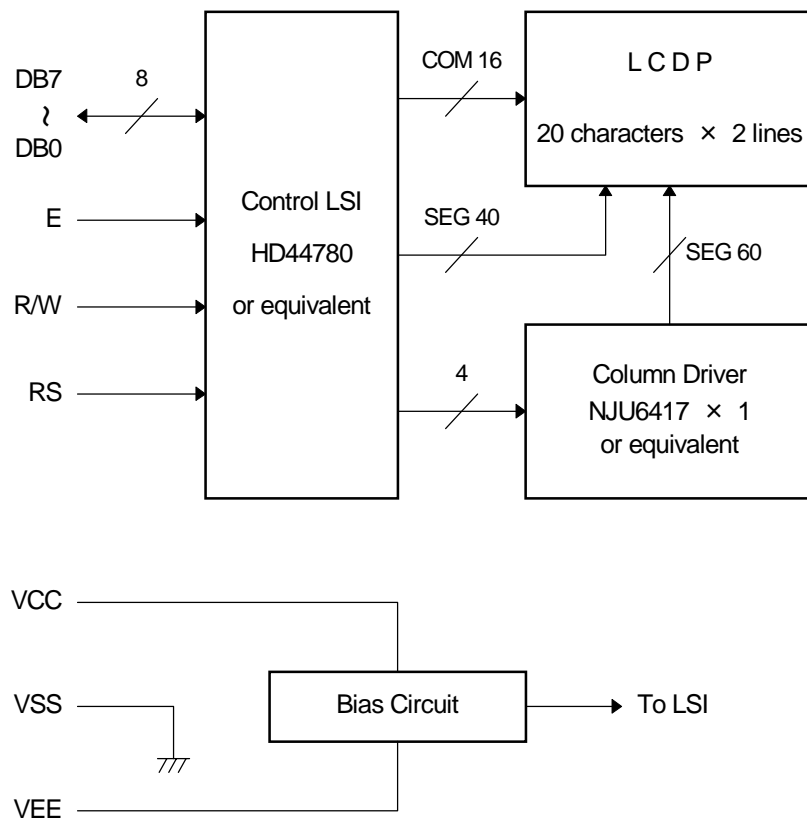

## 5. Test

No change on display and in operation under the following test condition.

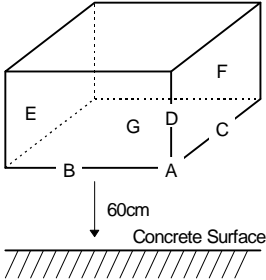
No.	Parameter	Conditions	Notes
1	High Temperature Operating	50°C ± 2°C, 96hrs (operation state)	
2	Low Temperature Operating	0°C ± 2°C, 96hrs (operation state)	3
3	High Temperature Storage	70°C ± 2°C, 96hrs	4
4	Low Temperature Storage	-20°C ± 2°C, 96hrs	3, 4
5	Damp Proof Test	40°C ± 2°C, 90~95%RH, 96hrs	3, 4
6	Vibration Test	Total fixed amplitude : 1.5mm Vibration Frequency : 10~55Hz One cycle 60 seconds to 3 directions of X, Y, Z for each 15 minutes	5
7	Shock Test	To be measured after dropping from 60cm high on the concrete surface in packing state. 	

Note 1 : Unless otherwise specified, tests will be conducted under the following condition.

Temperature : 20 ± 5°C

Humidity : 65 ± 5%

Note 2 : Unless otherwise specified, tests will be not conducted under functioning state.

Note 3 : No dew condensation to be observed.

Note 4 : The function test shall be conducted after 4 hours storage at the normal temperature and humidity after removed from the test chamber.

Note 5 : Vibration test will be conducted to the product itself without putting it in a container.

## 6. Appearance Standards

### 6.1. Inspection conditions

The LCD shall be inspected under 40W white fluorescent light.

The distance between the eyes and the sample shall be more than 30cm.

All directions for inspecting the sample should be within 45° against perpendicular line.



### 6.2. Definition of applicable Zones



A Zone : Active display area

B Zone : Area from outside of "A Zone" to validity viewing area

C Zone : Rest parts

A Zone + B Zone = Validity viewing area

6.3.Standards

No.	Parameter	Criteria																																																										
1	Black and White Spots, Foreign Substances	<p>(1) Round Shape</p> <table border="1"> <thead> <tr> <th rowspan="2">Dimension (mm) \ Zone</th> <th colspan="3">Acceptable Number</th> </tr> <tr> <th>A</th> <th>B</th> <th>C</th> </tr> </thead> <tbody> <tr> <td><math>D \leq 0.1</math></td> <td>*</td> <td>*</td> <td>*</td> </tr> <tr> <td><math>0.1 &lt; D \leq 0.2</math></td> <td>5</td> <td>5</td> <td>*</td> </tr> <tr> <td><math>0.2 &lt; D \leq 0.3</math></td> <td>0</td> <td>1</td> <td>*</td> </tr> <tr> <td><math>0.3 &lt; D</math></td> <td>0</td> <td>0</td> <td>*</td> </tr> </tbody> </table> <p><math>D = ( \text{Long} + \text{Short} ) / 2</math> * : Disregard</p> <p>(2) Line Shape</p> <table border="1"> <thead> <tr> <th colspan="2">Zone</th> <th colspan="3">Acceptable Number</th> </tr> <tr> <th>X(mm)</th> <th>Y(mm)</th> <th>A</th> <th>B</th> <th>C</th> </tr> </thead> <tbody> <tr> <td>—</td> <td><math>0.02 \geq W</math></td> <td>*</td> <td>*</td> <td>*</td> </tr> <tr> <td><math>2.0 \geq L</math></td> <td><math>0.03 \geq W</math></td> <td>3</td> <td>3</td> <td>*</td> </tr> <tr> <td><math>1.0 \geq L</math></td> <td><math>0.04 \geq W</math></td> <td>1</td> <td>2</td> <td>*</td> </tr> <tr> <td><math>1.0 \geq L</math></td> <td><math>0.05 \geq W</math></td> <td>0</td> <td>2</td> <td>*</td> </tr> <tr> <td>—</td> <td><math>0.05 &lt; W</math></td> <td colspan="3">In the same way (1)</td> </tr> </tbody> </table> <p>X : Length Y : Width * : Disregard</p> <p>Total defects shall not exceed 5.</p>	Dimension (mm) \ Zone	Acceptable Number			A	B	C	$D \leq 0.1$	*	*	*	$0.1 < D \leq 0.2$	5	5	*	$0.2 < D \leq 0.3$	0	1	*	$0.3 < D$	0	0	*	Zone		Acceptable Number			X(mm)	Y(mm)	A	B	C	—	$0.02 \geq W$	*	*	*	$2.0 \geq L$	$0.03 \geq W$	3	3	*	$1.0 \geq L$	$0.04 \geq W$	1	2	*	$1.0 \geq L$	$0.05 \geq W$	0	2	*	—	$0.05 < W$	In the same way (1)		
Dimension (mm) \ Zone	Acceptable Number																																																											
	A	B	C																																																									
$D \leq 0.1$	*	*	*																																																									
$0.1 < D \leq 0.2$	5	5	*																																																									
$0.2 < D \leq 0.3$	0	1	*																																																									
$0.3 < D$	0	0	*																																																									
Zone		Acceptable Number																																																										
X(mm)	Y(mm)	A	B	C																																																								
—	$0.02 \geq W$	*	*	*																																																								
$2.0 \geq L$	$0.03 \geq W$	3	3	*																																																								
$1.0 \geq L$	$0.04 \geq W$	1	2	*																																																								
$1.0 \geq L$	$0.05 \geq W$	0	2	*																																																								
—	$0.05 < W$	In the same way (1)																																																										
2	Air Bubbles (between glass & polarizer)	<table border="1"> <thead> <tr> <th rowspan="2">Dimension (mm) \ Zone</th> <th colspan="3">Acceptable Number</th> </tr> <tr> <th>A</th> <th>B</th> <th>C</th> </tr> </thead> <tbody> <tr> <td><math>D \leq 0.15</math></td> <td>*</td> <td>*</td> <td>*</td> </tr> <tr> <td><math>0.15 &lt; D \leq 0.3</math></td> <td>2</td> <td>3</td> <td>*</td> </tr> <tr> <td><math>0.3 &lt; D \leq 0.5</math></td> <td>1</td> <td>2</td> <td>*</td> </tr> <tr> <td><math>0.5 &lt; D \leq 1.0</math></td> <td>0</td> <td>1</td> <td>*</td> </tr> </tbody> </table> <p>* : Disregard</p> <p>Total defects shall not exceed 3.</p>	Dimension (mm) \ Zone	Acceptable Number			A	B	C	$D \leq 0.15$	*	*	*	$0.15 < D \leq 0.3$	2	3	*	$0.3 < D \leq 0.5$	1	2	*	$0.5 < D \leq 1.0$	0	1	*																																			
Dimension (mm) \ Zone	Acceptable Number																																																											
	A	B	C																																																									
$D \leq 0.15$	*	*	*																																																									
$0.15 < D \leq 0.3$	2	3	*																																																									
$0.3 < D \leq 0.5$	1	2	*																																																									
$0.5 < D \leq 1.0$	0	1	*																																																									

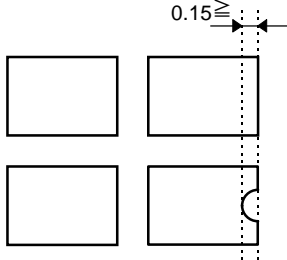
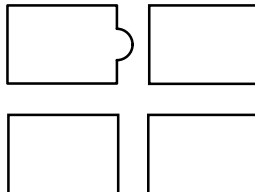
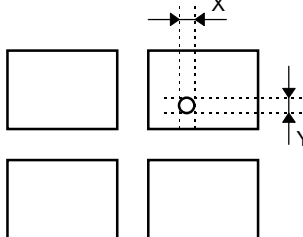

No.	Parameter	Criteria
3	The Shape of Dot	<p>(1) Dot Shape (with Dent)</p>  <p>As per the sketch of left hand.</p> <p>(2) Dot Shape (with Projection)</p>  <p>Should not be connected to next dot.</p> <p>(3) Pin Hole</p>  <p><math>(X+Y) / 2 \leq 0.2\text{mm}</math> (Less than 0.1mm is no counted.)</p> <p>Total defects shall not exceed 5.</p>
4	Polarizer Scratches	Not to be conspicuous defects.
5	Polarizer Dirts	If the stains are removed easily from LCDP surface, the module is not defective.
6	Color Variation	Not to be conspicuous defects.

## 7. Code System of Production Lot

The production lot of module is specified as follows.

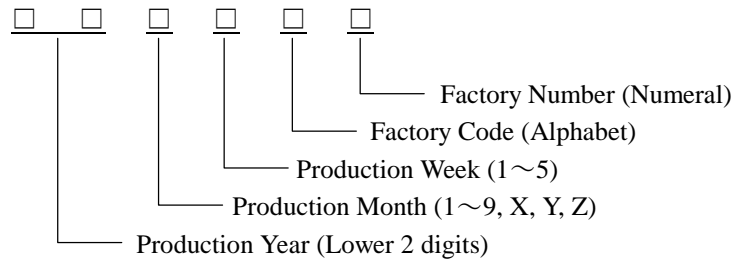

## 8. Type Number

The type number of module is specified on the back of module as follows.

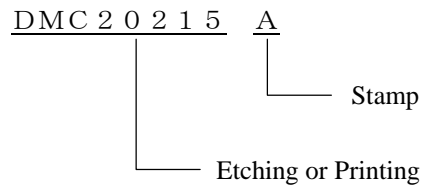

## 9. Applying Precautions

Please contact us when questions and/or new problems not specified in this specifications arise.

## 10. Handling Precautions

Optrex Products are designed for use in ordinary electronic devices such as business machines, telecommunications equipment, measurement devices and etc..

Optrex Products are not designed, intended, or authorized for use in any application in which the failure of the product could result in a situation where personal injury or death may occur. These applications include, but are not limited to, life-sustaining equipment, nuclear control devices, aerospace equipment, devices related to hazardous or flammable materials, etc. (If Buyer intends to purchase or use the Optrex Products for such unintended or unauthorized applications, Buyer must secure prior written consent to such use by a responsible officer of Optrex Corporation.) Should Buyer purchase or use Optrex Products for any such unintended or unauthorized application (without such consent), Buyer shall indemnify and hold Optrex and its officers, employees, subsidiaries, affiliates and distributors harmless against all claims, costs, damages and expenses, and reasonable attorney's fees, arising out of, directly or indirectly, any claim of personal injury or death associated with such unintended or unauthorized use, even if such claim alleges that Optrex was negligent regarding the design or manufacture of the part.

- 1) LCD may be broken because it is made of glass.
- 2) Polarizer is a soft material and can easily be scratched.
- 3) Please avoid static electricity.
  - ① Please be sure to ground human body and electric appliances during work.
  - ② It is preferable to use conductive mat on table and wear cotton clothes or conduction processed fiber. Synthetic fiber is not recommended.
  - ③ Please slowly peel off protective film, because static electricity may be charged.
- 4) If it is necessary to store LCD modules for a long time, please comply with the following procedures. If storage condition is not satisfactory, display (especially polarizer) may be deteriorated or soldering I/O terminals may become difficult (some oxide is generated at I/O terminals plating).
  - ① Store as delivered by Optrex
  - ② If you store as unpacked, put in anti-static bag, seal its opening and store where it is not subjected to direct sunshine nor fluorescent lamp.
  - ③ Store at temperature 0 to +35°C and at low humidity. Please refer to our specification sheets for storage temperature range and humidity condition.
- 5) The module does not contain excess current limiter.  
Please design the limiter to cut excess current in your power supply circuit.
- 6) Liquid crystal may be leaked when display is broken. Never taste it. If your hands or clothes touch it, please immediately wash using soap.
- 7) The connection between the bezel and Vss (GND) is not specified in the module.  
(Some module do not maintain connection between them.)  
Please consult OPTREX to specify the connection.

Optrex shall not be responsible for any infringement of industrial property rights of third parties in any country arising out of the application or use of Optrex Products, except which directly concern the structure or production of such products.