



## 2SD1616/A

## NPN SILICON TRANSISTOR

### NPN EPITAXIAL SILICON TRANSISTOR

#### DESCRIPTION

- \* Audio frequency power amplifier
- \* Medium speed switching

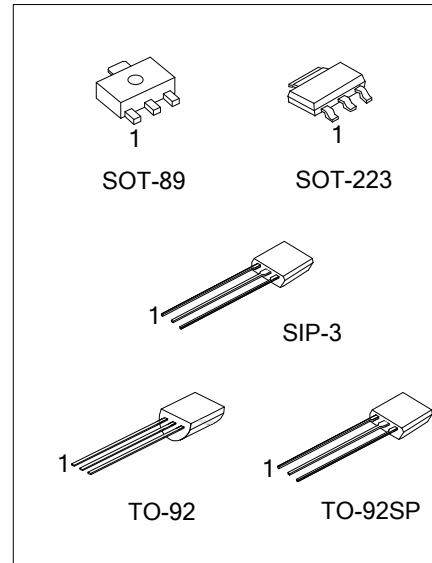

#### ORDERING INFORMATION

Ordering Number		Package	Pin Assignment			Packing
Lead Free Plating	Halogen-Free		1	2	3	
2SD1616L-x-AA3-B	2SD1616G-x-AA3-B	SOT-223	B	C	E	Tape Reel
2SD1616L-x-AB3-R	2SD1616G-x-AB3-R	SOT-89	B	C	E	Tape Reel
2SD1616L-x-G03-K	2SD1616G-x-G03-K	SIP-3	E	C	B	Bulk
2SD1616L-x-T92-B	2SD1616G-x-T92-B	TO-92	E	C	B	Tape Box
2SD1616L-x-T92-K	2SD1616G-x-T92-K	TO-92	E	C	B	Bulk
2SD1616L-x-T9S-K	2SD1616G-x-T9S-K	TO-92SP	E	C	B	Bulk
2SD1616AL-x-AA3-R	2SD1616AG-x-AA3-R	SOT-223	B	C	E	Tape Reel
2SD1616AL-x-AB3-R	2SD1616AG-x-AB3-R	SOT-89	B	C	E	Tape Reel
2SD1616AL-x-G03-K	2SD1616AG-x-G03-K	SIP-3	E	C	B	Bulk
2SD1616AL-x-T92-B	2SD1616AG-x-T92-B	TO-92	E	C	B	Tape Box
2SD1616AL-x-T92-K	2SD1616AG-x-T92-K	TO-92	E	C	B	Bulk
2SD1616AL-x-T9S-K	2SD1616AG-x-T9S-K	TO-92SP	E	C	B	Bulk

Note: Pin Assignment: B: Base C: Collector E: Emitter

<p>2SD1616G-x-AA3-B</p>	<p>(1) B: Tape Box, K: Bulk, R: Tape Reel  (2) AA3: SOT-223, AB3: SOT-89, G03: SIP-3, T92: TO-92, T9S: TO-92S  (3) x: refer to Classification of <math>h_{FE1}</math>  (4) G: Halogen Free and Lead Free, L: Lead Free</p>
-------------------------	--

# 2SD1616/A

## NPN SILICON TRANSISTOR

### MARKING

PACKAGE	MARKING	
	2SD1616	2SD1616A
SOT-223		
SOT-89		
SIP-3		
TO-92		
TO-92SP		

# 2SD1616/A

## NPN SILICON TRANSISTOR

### ■ ABSOLUTE MAXIMUM RATINGS (T<sub>A</sub>=25°C, unless otherwise specified)

PARAMETER		SYMBOL	RATINGS	UNIT
Collector to Base Voltage	2SD1616	V <sub>CBO</sub>	60	V
	2SD1616A		120	
Collector to Emitter Voltage	2SD1616	V <sub>CEO</sub>	50	V
	2SD1616A		60	
Emitter to Base Voltage		V <sub>EBO</sub>	6	V
Collector Current	DC	I <sub>C</sub>	1	A
	Pulse(Note2)	I <sub>CM</sub>	2	A
Total Power Dissipation	SOT-223	P <sub>C</sub>	800	mW
	SOT-89		500	mW
	SIP-3		400	mW
	TO-92/TO-92SP		750	mW
Junction Temperature		T <sub>J</sub>	+150	°C
Storage Temperature		T <sub>STG</sub>	-55 ~ +150	°C

Notes: 1. Absolute maximum ratings are those values beyond which the device could be permanently damaged.

Absolute maximum ratings are stress ratings only and functional device operation is not implied.

2. Pulse width ≤ 10ms, Duty cycle < 50%.

### ■ ELECTRICAL CHARACTERISTICS (T<sub>A</sub>=25°C, unless otherwise specified)

PARAMETER		SYMBOL	TEST CONDITIONS	MIN	TYP	MAX	UNIT
Collector to Base Breakdown Voltage	2SD1616	BV <sub>CBO</sub>	I <sub>C</sub> =100μA, I <sub>E</sub> =0	60			V
	2SD1616A			120			V
Collector to Emitter Breakdown Voltage	2SD1616	BV <sub>CEO</sub>	I <sub>C</sub> =10mA, I <sub>B</sub> =0	50			V
	2SD1616A			60			V
Emitter to Base Breakdown Voltage		BV <sub>EBO</sub>	I <sub>E</sub> =10mA, I <sub>C</sub> =0	6			V
Collector-Emitter Saturation Voltage		V <sub>CE(SAT)</sub>	I <sub>C</sub> =1A, I <sub>B</sub> =50mA		0.15	0.3	V
Base-Emitter Saturation Voltage		V <sub>BE(SAT)</sub>	I <sub>C</sub> =1A, I <sub>B</sub> =50mA		0.9	1.2	V
Base Emitter On Voltage		V <sub>BE(ON)</sub>	V <sub>CE</sub> =2V, I <sub>C</sub> =50mA	600	640	720	mV
Collector Cut-Off Current		I <sub>CBO</sub>	V <sub>CB</sub> =60V			100	nA
Emitter Cut-Off Current		I <sub>EBO</sub>	V <sub>EB</sub> =6V			100	nA
DC Current Gain	h <sub>FE1</sub>	h <sub>FE1</sub>	V <sub>CE</sub> =2V, I <sub>C</sub> =100mA	135		600	
	h <sub>FE2</sub>			h <sub>FE2</sub>	81		
Transition Frequency		f <sub>T</sub>	V <sub>CE</sub> =2V, I <sub>C</sub> =100mA	100	160		MHz
Output Capacitance		C <sub>ob</sub>	V <sub>CB</sub> =10V, f=1MHz			19	pF
Turn On Time		t <sub>ON</sub>	V <sub>CE</sub> =10V, I <sub>C</sub> =100mA		0.07		μs
Storage Time		t <sub>STG</sub>	I <sub>B1</sub> =-I <sub>B2</sub> =10mA		0.95		μs
Fall Time		t <sub>F</sub>	V <sub>BE(OFF)</sub> =-2 ~ -3V		0.07		μs

### ■ CLASSIFICATION OF h<sub>FE1</sub>

RANK	Y	G	L
h <sub>FE1</sub>	135 ~ 270	200 ~ 400	300 ~ 600

## TYPICAL CHARACTERISTICS

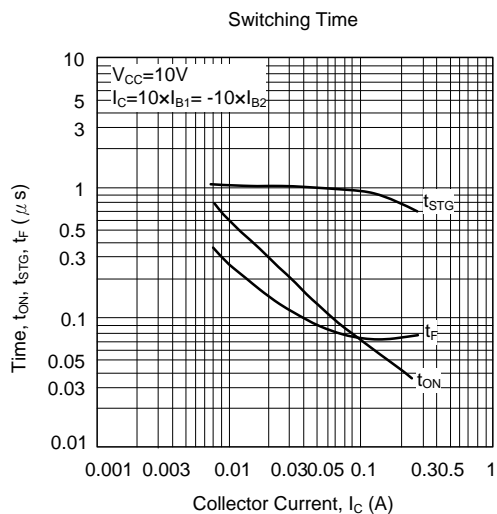
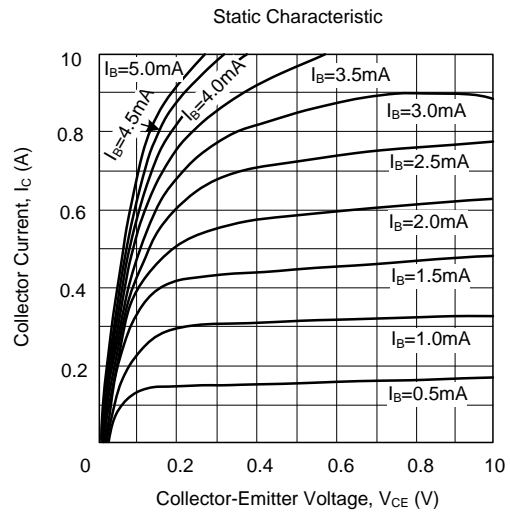
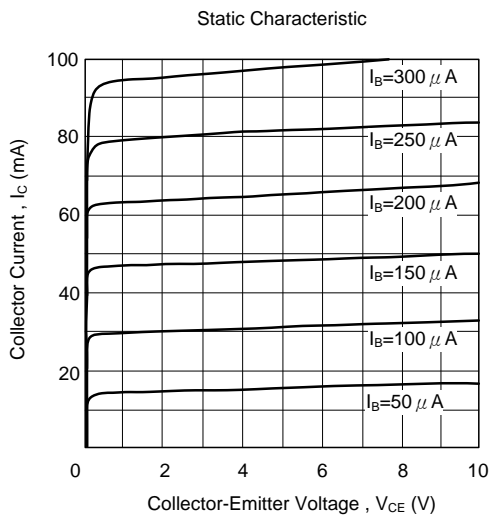
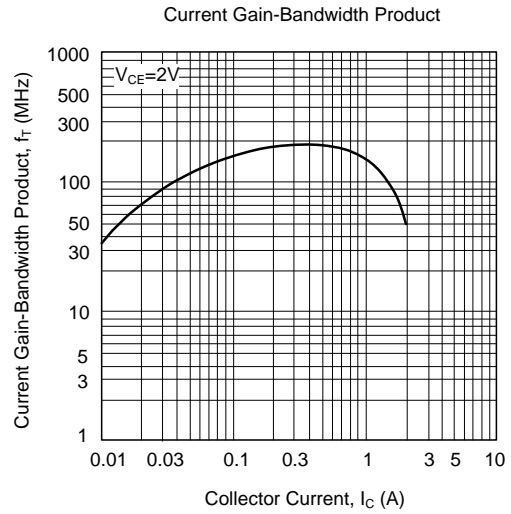
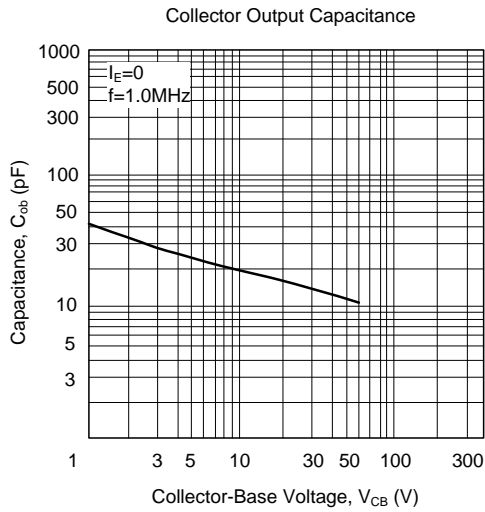

## ■ TYPICAL CHARACTERISTICS (Cont.)

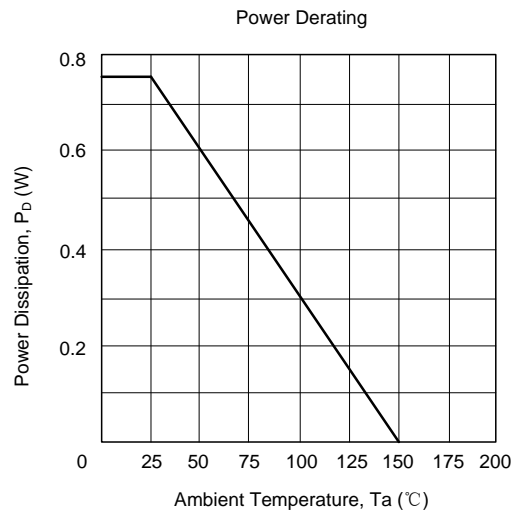
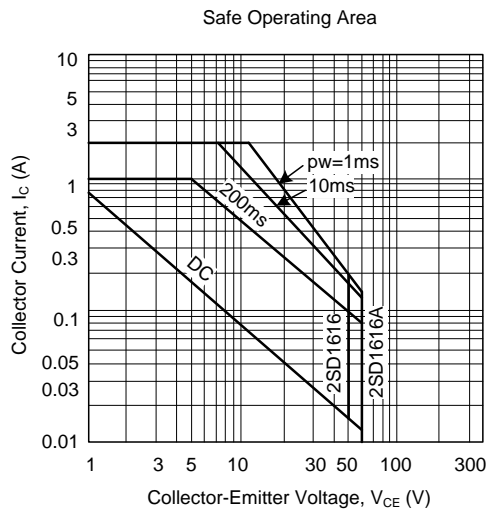
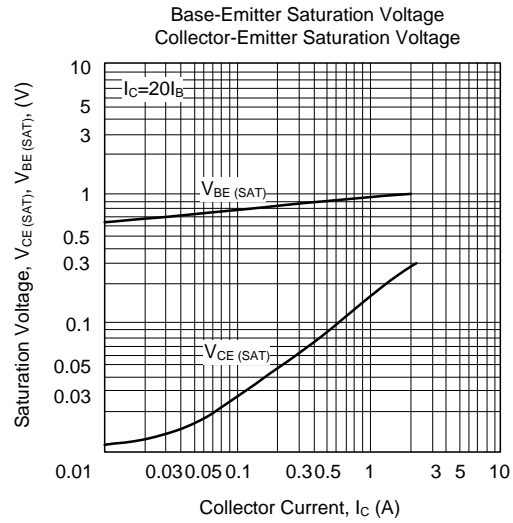
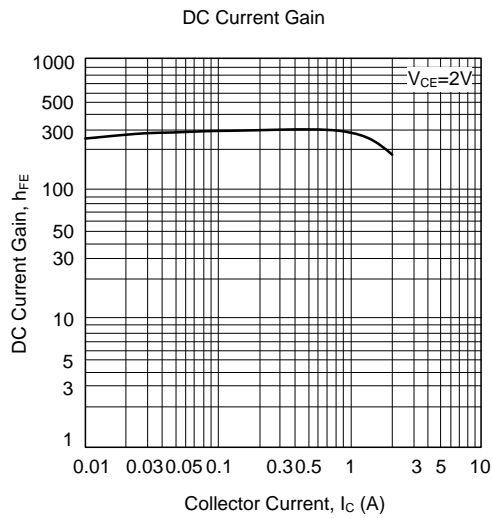

UTC assumes no responsibility for equipment failures that result from using products at values that exceed, even momentarily, rated values (such as maximum ratings, operating condition ranges, or other parameters) listed in products specifications of any and all UTC products described or contained herein. UTC products are not designed for use in life support appliances, devices or systems where malfunction of these products can be reasonably expected to result in personal injury. Reproduction in whole or in part is prohibited without the prior written consent of the copyright owner. UTC reserves the right to make changes to information published in this document, including without limitation specifications and product descriptions, at any time and without notice. This document supersedes and replaces all information supplied prior to the publication hereof.