

- Designed for Complementary Use with TIP140, TIP141 and TIP142
- 125 W at 25°C Case Temperature
- 10 A Continuous Collector Current
- Minimum h_{FE} of 1000 at 4 V, 5 A

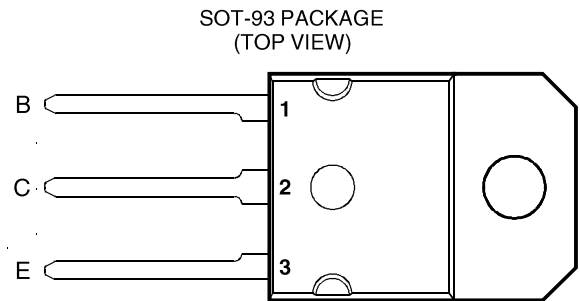

Pin 2 is in electrical contact with the mounting base.

absolute maximum ratings at 25°C case temperature (unless otherwise noted)

RATING		SYMBOL	VALUE	UNIT
Collector-base voltage ($I_E = 0$)	TIP145	V_{CBO}	-60	V
	TIP146		-80	
	TIP147		-100	
Collector-emitter voltage ($I_B = 0$)	TIP145	V_{CEO}	-60	V
	TIP146		-80	
	TIP147		-100	
Emitter-base voltage		V_{EBO}	-5	V
Continuous collector current		I_C	-10	A
Peak collector current (see Note 1)		I_{CM}	-15	A
Continuous base current		I_B	-0.5	A
Continuous device dissipation at (or below) 25°C case temperature (see Note 2)		P_{tot}	125	W
Continuous device dissipation at (or below) 25°C free air temperature (see Note 3)		P_{tot}	3.5	W
Unclamped inductive load energy (see Note 4)		$\frac{1}{2}LI_C^2$	100	mJ
Operating junction temperature range		T_j	-65 to +150	°C
Storage temperature range		T_{stg}	-65 to +150	°C
Lead temperature 3.2 mm from case for 10 seconds		T_L	260	°C

- NOTES: 1. This value applies for $t_p \leq 0.3$ ms, duty cycle $\leq 10\%$.
 2. Derate linearly to 150°C case temperature at the rate of 1 W/°C.
 3. Derate linearly to 150°C free air temperature at the rate of 28 mW/°C.
 4. This rating is based on the capability of the transistor to operate safely in a circuit of: L = 20 mH, $I_{B(on)} = -5$ mA, $R_{BE} = 100 \Omega$, $V_{BE(off)} = 0$, $R_S = 0.1 \Omega$, $V_{CC} = -20$ V.

TIP145, TIP146, TIP147

PNP SILICON POWER DARLINGTONS

electrical characteristics at 25°C case temperature

PARAMETER		TEST CONDITIONS			MIN	TYP	MAX	UNIT
$V_{(BR)CEO}$	Collector-emitter breakdown voltage	$I_C = -30 \text{ mA}$ (see Note 5)	$I_B = 0$	TIP145 TIP146 TIP147	-60 -80 -100			V
I_{CEO}	Collector-emitter cut-off current	$V_{CE} = -30 \text{ V}$ $V_{CE} = -40 \text{ V}$ $V_{CE} = -50 \text{ V}$	$I_B = 0$ $I_B = 0$ $I_B = 0$	TIP145 TIP146 TIP147			-2 -2 -2	mA
I_{CBO}	Collector cut-off current	$V_{CB} = -60 \text{ V}$ $V_{CB} = -80 \text{ V}$ $V_{CB} = -100 \text{ V}$	$I_E = 0$ $I_E = 0$ $I_E = 0$	TIP145 TIP146 TIP147			-1 -1 -1	mA
I_{EBO}	Emitter cut-off current	$V_{EB} = -5 \text{ V}$	$I_C = 0$				-2	mA
h_{FE}	Forward current transfer ratio	$V_{CE} = -4 \text{ V}$ $V_{CE} = -4 \text{ V}$	$I_C = -5 \text{ A}$ $I_C = -10 \text{ A}$	(see Notes 5 and 6)	1000 500			
$V_{CE(sat)}$	Collector-emitter saturation voltage	$I_B = -10 \text{ mA}$ $I_B = -40 \text{ mA}$	$I_C = -5 \text{ A}$ $I_C = -10 \text{ A}$	(see Notes 5 and 6)			-2 -3	V
V_{BE}	Base-emitter voltage	$V_{CE} = -4 \text{ V}$	$I_C = -10 \text{ A}$	(see Notes 5 and 6)			-3	V
V_{EC}	Parallel diode forward voltage	$I_E = -10 \text{ A}$	$I_B = 0$	(see Notes 5 and 6)			-3.5	V

NOTES: 5. These parameters must be measured using pulse techniques, $t_p = 300 \mu\text{s}$, duty cycle $\leq 2\%$.

6. These parameters must be measured using voltage-sensing contacts, separate from the current carrying contacts.

resistive-load-switching characteristics at 25°C case temperature

PARAMETER		TEST CONDITIONS †			MIN	TYP	MAX	UNIT
t_{on}	Turn-on time	$I_C = -10 \text{ A}$	$I_{B(on)} = -40 \text{ mA}$	$I_{B(off)} = 40 \text{ mA}$		0.9		μs
t_{off}	Turn-off time	$V_{BE(off)} = 4.2 \text{ V}$	$R_L = 3 \Omega$	$t_p = 20 \mu\text{s}$, dc $\leq 2\%$		11		μs

† Voltage and current values shown are nominal; exact values vary slightly with transistor parameters.

TYPICAL CHARACTERISTICS

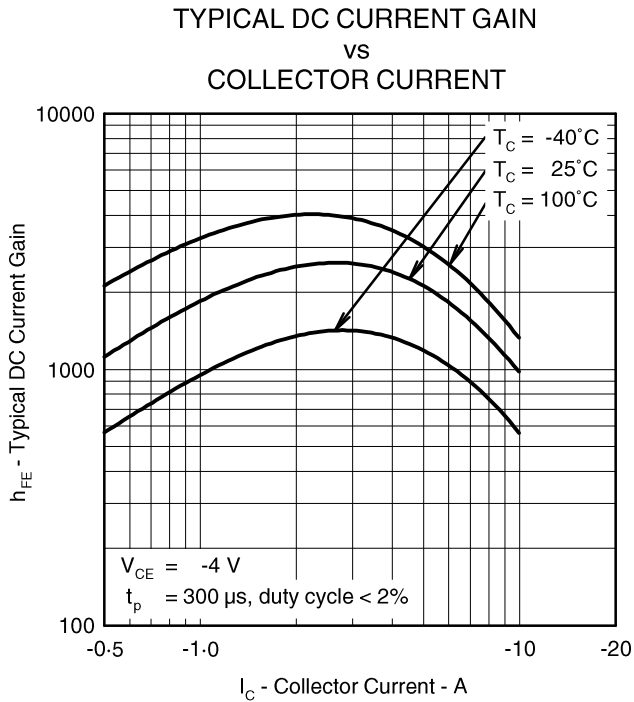

Figure 1.

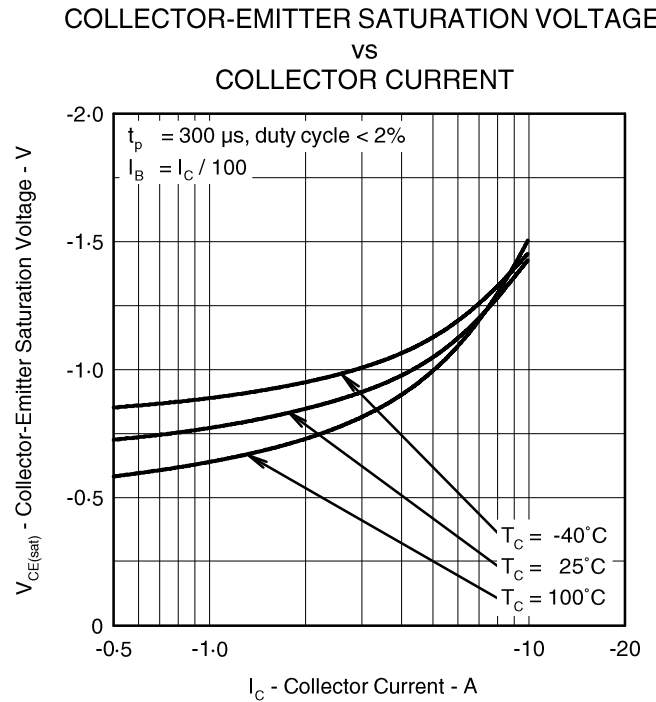

Figure 2.

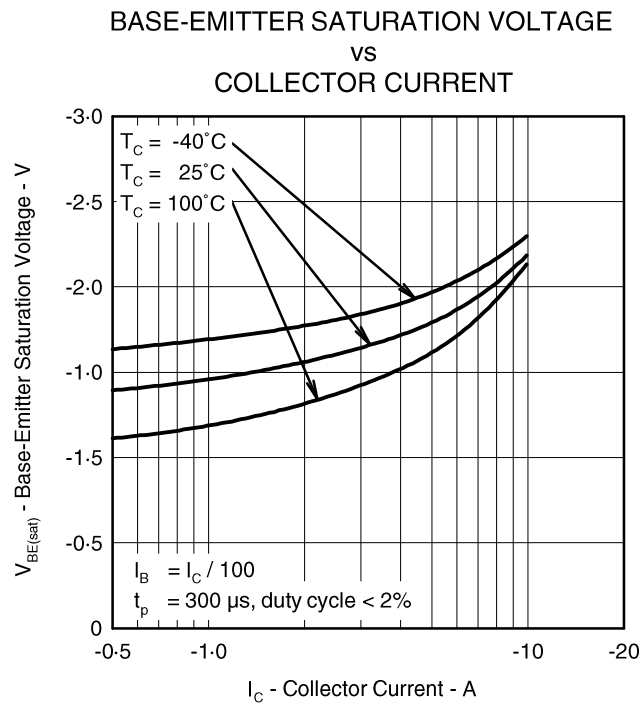

Figure 3.

TIP145, TIP146, TIP147 PNP SILICON POWER DARLINGTONS

MAXIMUM SAFE OPERATING REGIONS

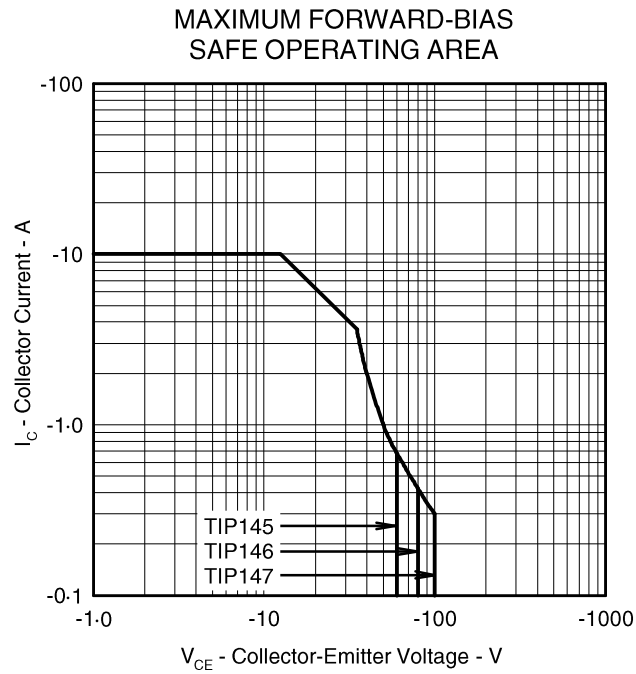

Figure 4.

THERMAL INFORMATION

MAXIMUM POWER DISSIPATION vs CASE TEMPERATURE

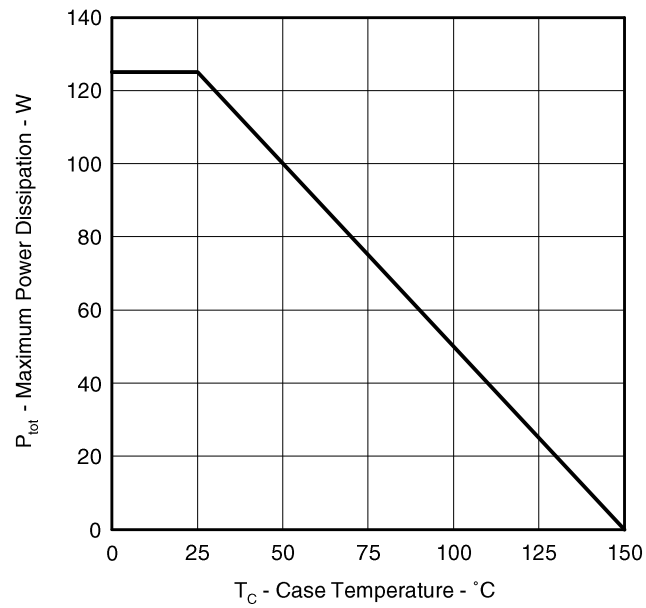

Figure 5.

TIP145, TIP146, TIP147 PNP SILICON POWER DARLINGTONS

MECHANICAL DATA

SOT-93

3-pin plastic flange-mount package

This single-in-line package consists of a circuit mounted on a lead frame and encapsulated within a plastic compound. The compound will withstand soldering temperature with no deformation, and circuit performance characteristics will remain stable when operated in high humidity conditions. Leads require no additional cleaning or processing when used in soldered assembly.

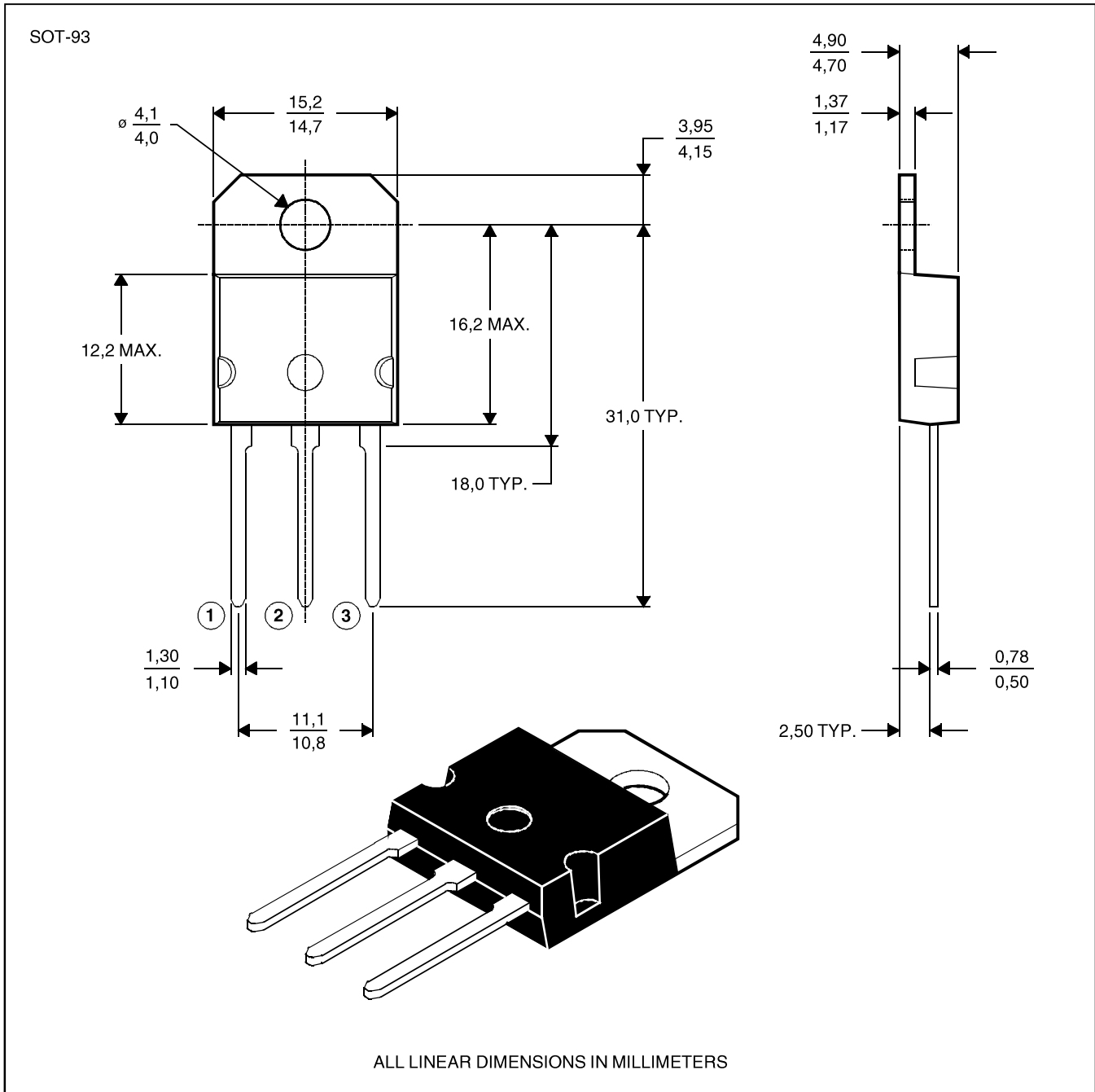

NOTE A: The centre pin is in electrical contact with the mounting tab.