

# FS3VS-9

HIGH-SPEED SWITCHING USE

**FS3VS-9**



- $V_{DSS}$  ..... 450V
- $r_{DS(ON)}$  (MAX) .....  $3.5\Omega$
- $I_D$  ..... 3A

**OUTLINE DRAWING** Dimensions in mm

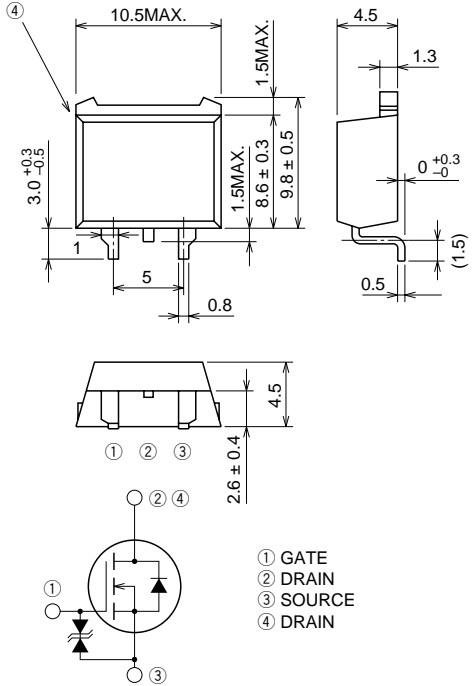

① GATE  
② DRAIN  
③ SOURCE  
④ DRAIN

**TO-220S**

## APPLICATION

SMPS, DC-DC Converter, battery charger, power supply of printer, copier, HDD, FDD, TV, VCR, personal computer etc.

## MAXIMUM RATINGS (Tc = 25°C)

Symbol	Parameter	Conditions	Ratings	Unit
$V_{DSS}$	Drain-source voltage	$V_{GS} = 0V$	450	V
$V_{GSS}$	Gate-source voltage	$V_{DS} = 0V$	$\pm 30$	V
$I_D$	Drain current		3	A
$I_{DM}$	Drain current (Pulsed)		9	A
$P_D$	Maximum power dissipation		60	W
$T_{ch}$	Channel temperature		-55 ~ +150	°C
$T_{stg}$	Storage temperature		-55 ~ +150	°C
—	Weight	Typical value	1.2	g

**ELECTRICAL CHARACTERISTICS** (T<sub>ch</sub> = 25°C)

Symbol	Parameter	Test conditions	Limits			Unit
			Min.	Typ.	Max.	
V (BR) DSS	Drain-source breakdown voltage	I <sub>D</sub> = 1mA, V <sub>GS</sub> = 0V	450	—	—	V
V (BR) GSS	Gate-source breakdown voltage	I <sub>G</sub> = ±100μA, V <sub>DS</sub> = 0V	±30	—	—	V
I <sub>GSS</sub>	Gate-source leakage current	V <sub>GS</sub> = ±25V, V <sub>DS</sub> = 0V	—	—	±10	μA
I <sub>DSS</sub>	Drain-source leakage current	V <sub>DS</sub> = 450V, V <sub>GS</sub> = 0V	—	—	1	mA
V <sub>GS</sub> (th)	Gate-source threshold voltage	I <sub>D</sub> = 1mA, V <sub>DS</sub> = 10V	2	3	4	V
r <sub>DS</sub> (ON)	Drain-source on-state resistance	I <sub>D</sub> = 1A, V <sub>GS</sub> = 10V	—	2.7	3.5	Ω
V <sub>DS</sub> (ON)	Drain-source on-state voltage	I <sub>D</sub> = 1A, V <sub>GS</sub> = 10V	—	2.7	3.5	V
y <sub>fs</sub>	Forward transfer admittance	I <sub>D</sub> = 1A, V <sub>DS</sub> = 10V	1.0	1.5	—	S
C <sub>iss</sub>	Input capacitance	V <sub>DS</sub> = 25V, V <sub>GS</sub> = 0V, f = 1MHz	—	300	—	pF
C <sub>oss</sub>	Output capacitance		—	35	—	pF
C <sub>rss</sub>	Reverse transfer capacitance		—	6	—	pF
t <sub>d</sub> (on)	Turn-on delay time	V <sub>DD</sub> = 200V, I <sub>D</sub> = 1A, V <sub>GS</sub> = 10V, R <sub>GEN</sub> = R <sub>GS</sub> = 50Ω	—	13	—	ns
t <sub>r</sub>	Rise time		—	10	—	ns
t <sub>d</sub> (off)	Turn-off delay time		—	30	—	ns
t <sub>f</sub>	Fall time		—	30	—	ns
V <sub>SD</sub>	Source-drain voltage	I <sub>S</sub> = 1A, V <sub>GS</sub> = 0V	—	1.5	2.0	V
R <sub>th</sub> (ch-c)	Thermal resistance	Channel to case	—	—	2.08	°C/W

**PERFORMANCE CURVES**

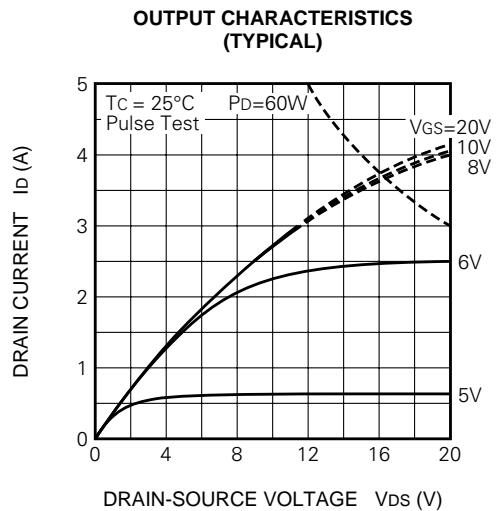
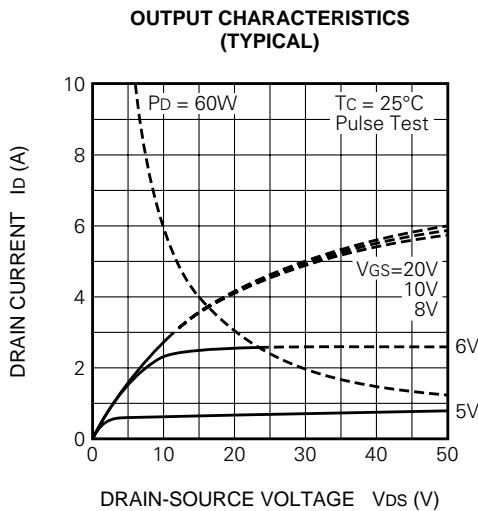
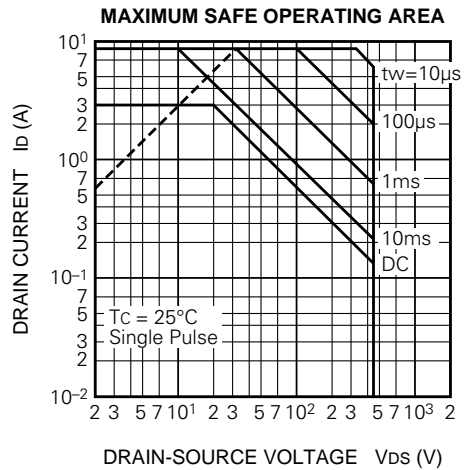
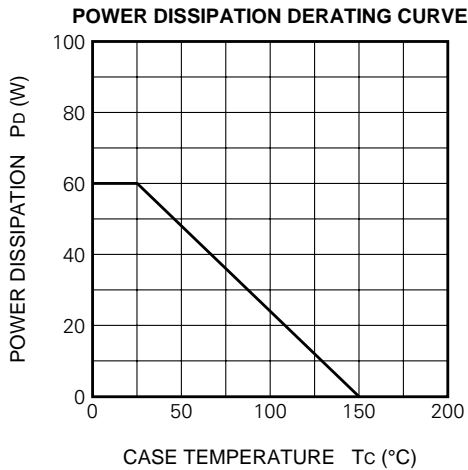

ON-STATE VOLTAGE VS. GATE-SOURCE VOLTAGE (TYPICAL)

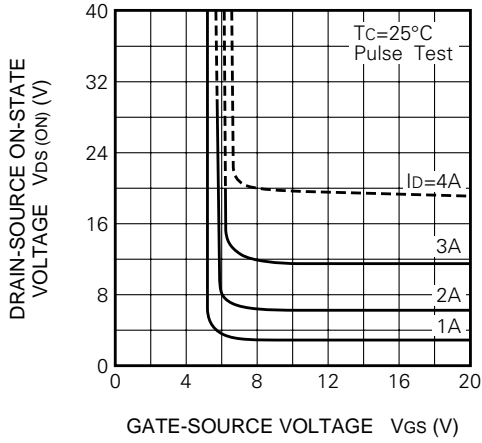

ON-STATE RESISTANCE VS. DRAIN CURRENT (TYPICAL)

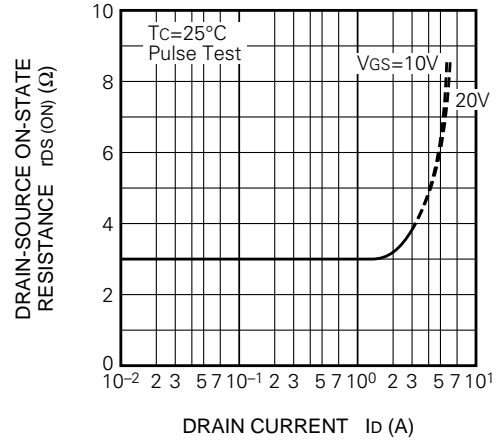

TRANSFER CHARACTERISTICS (TYPICAL)

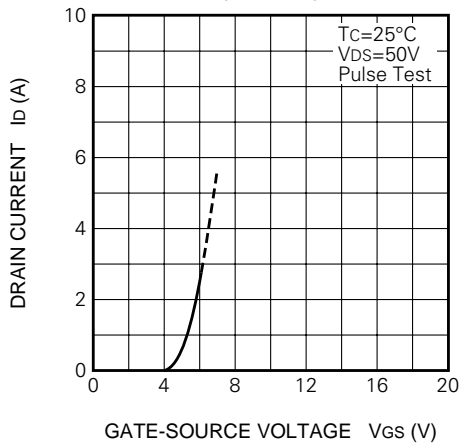

FORWARD TRANSFER ADMITTANCE VS. DRAIN CURRENT (TYPICAL)

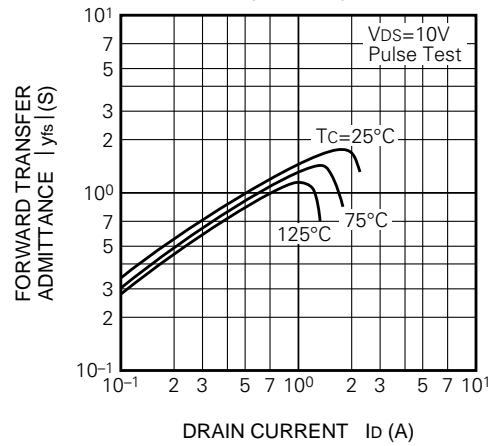

CAPACITANCE VS. DRAIN-SOURCE VOLTAGE (TYPICAL)

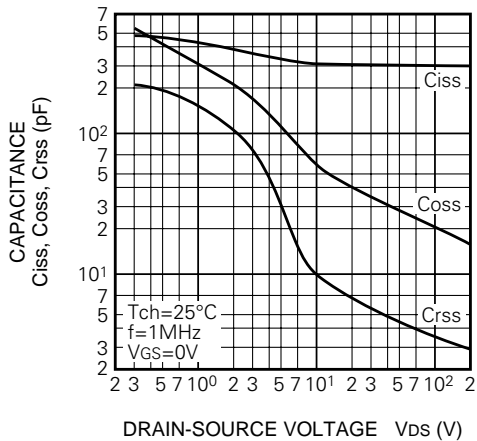

SWITCHING CHARACTERISTICS (TYPICAL)

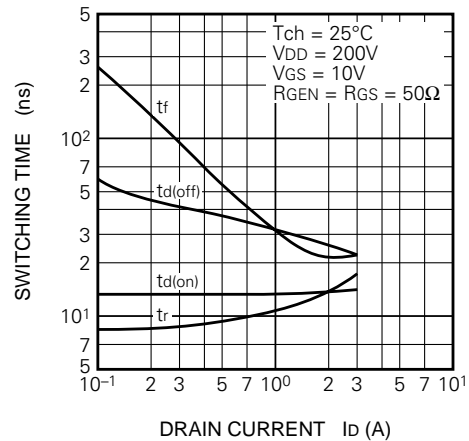

**GATE-SOURCE VOLTAGE VS. GATE CHARGE (TYPICAL)**

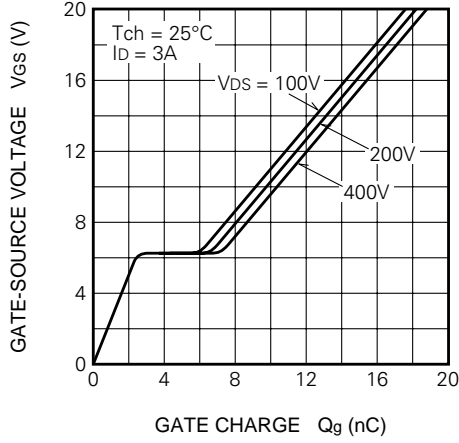

**SOURCE-DRAIN DIODE FORWARD CHARACTERISTICS (TYPICAL)**

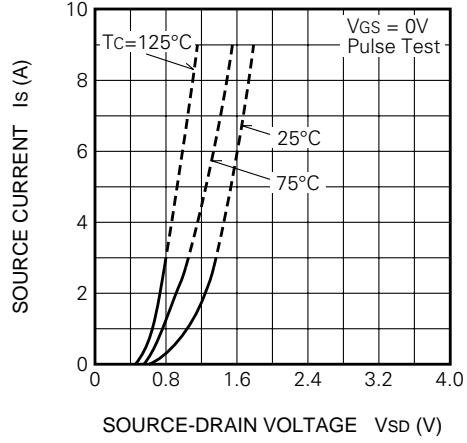

**ON-STATE RESISTANCE VS. CHANNEL TEMPERATURE (TYPICAL)**

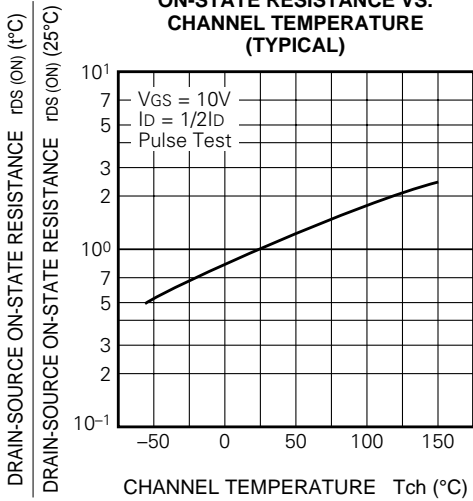

**THRESHOLD VOLTAGE VS. CHANNEL TEMPERATURE (TYPICAL)**

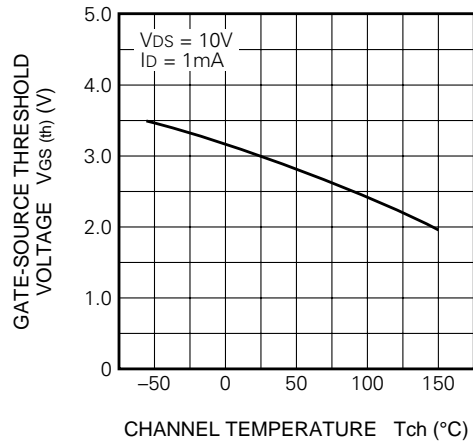

**BREAKDOWN VOLTAGE VS. CHANNEL TEMPERATURE (TYPICAL)**

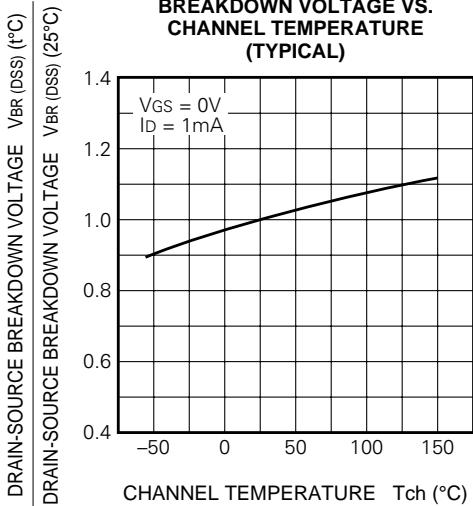

**TRANSIENT THERMAL IMPEDANCE CHARACTERISTICS**

