

DATA SHEET

TEA1110A

Low voltage versatile telephone
transmission circuit with dialler
interface

Product specification
Supersedes data of 1996 Nov 26
File under Integrated Circuits, IC03

1997 Apr 22

Low voltage versatile telephone transmission circuit with dialler interface

TEA1110A

FEATURES

- Low DC line voltage; operates down to 1.6 V (excluding voltage drop over external polarity guard)
- Voltage regulator with adjustable DC voltage
- Provides a supply for external circuits
- Symmetrical high impedance inputs (64 k Ω) for dynamic, magnetic or piezo-electric microphones
- Asymmetrical high impedance input (32 k Ω) for electret microphones
- DTMF input with confidence tone
- $\overline{\text{MUTE}}$ input for pulse or DTMF dialling
- Receiving amplifier for dynamic, magnetic or piezo-electric earpieces
- AGC line loss compensation for microphone and earpiece amplifiers.

APPLICATION

- Line powered telephone sets, cordless telephones, fax machines, answering machines.

GENERAL DESCRIPTION

The TEA1110A is a bipolar integrated circuit that performs all speech and line interface functions required in fully electronic telephone sets. It performs electronic switching between speech and dialling. The IC operates at a line voltage down to 1.6 V DC (with reduced performance) to facilitate the use of telephone sets connected in parallel.

All statements and values refer to all versions unless otherwise specified.

QUICK REFERENCE DATA

$I_{\text{line}} = 15 \text{ mA}$; $V_{\text{EE}} = 0 \text{ V}$; $R_{\text{SLPE}} = 20 \text{ }\Omega$; AGC pin connected to V_{EE} ; $Z_{\text{line}} = 600 \text{ }\Omega$; $f = 1 \text{ kHz}$; $T_{\text{amb}} = 25 \text{ }^\circ\text{C}$; unless otherwise specified.

SYMBOL	PARAMETER	CONDITIONS	MIN.	TYP.	MAX.	UNIT
I_{line}	line current operating range	normal operation	11	–	140	mA
		with reduced performance	1	–	11	mA
V_{LN}	DC line voltage		3.35	3.65	3.95	V
I_{CC}	internal current consumption	$V_{\text{CC}} = 2.9 \text{ V}$	–	1.1	1.4	mA
V_{CC}	supply voltage for peripherals	$I_{\text{P}} = 0 \text{ mA}$	–	2.9	–	V
G_{vtrx}	typical voltage gain microphone amplifier (not adjustable) receiving amplifier range	$V_{\text{MIC}} = 4 \text{ mV (RMS)}$	–	43.7	–	dB
		$V_{\text{IR}} = 4 \text{ mV (RMS)}$	19	–	33	dB
ΔG_{vtrx}	gain control range for microphone and receiving amplifiers with respect to $I_{\text{line}} = 15 \text{ mA}$	$I_{\text{line}} = 85 \text{ mA}$	–	5.9	–	dB
ΔG_{vtrxm}	gain reduction for microphone and receiving amplifiers	$\overline{\text{MUTE}} = \text{LOW}$	–	80	–	dB

ORDERING INFORMATION

TYPE NUMBER	PACKAGE		
	NAME	DESCRIPTION	VERSION
TEA1110A	DIP14	plastic dual in-line package; 14 leads (300 mil)	SOT27-1
TEA1110AT	SO14	plastic small outline package; 14 leads; body width 3.9 mm	SOT108-1

Low voltage versatile telephone transmission circuit with dialler interface

TEA1110A

BLOCK DIAGRAM

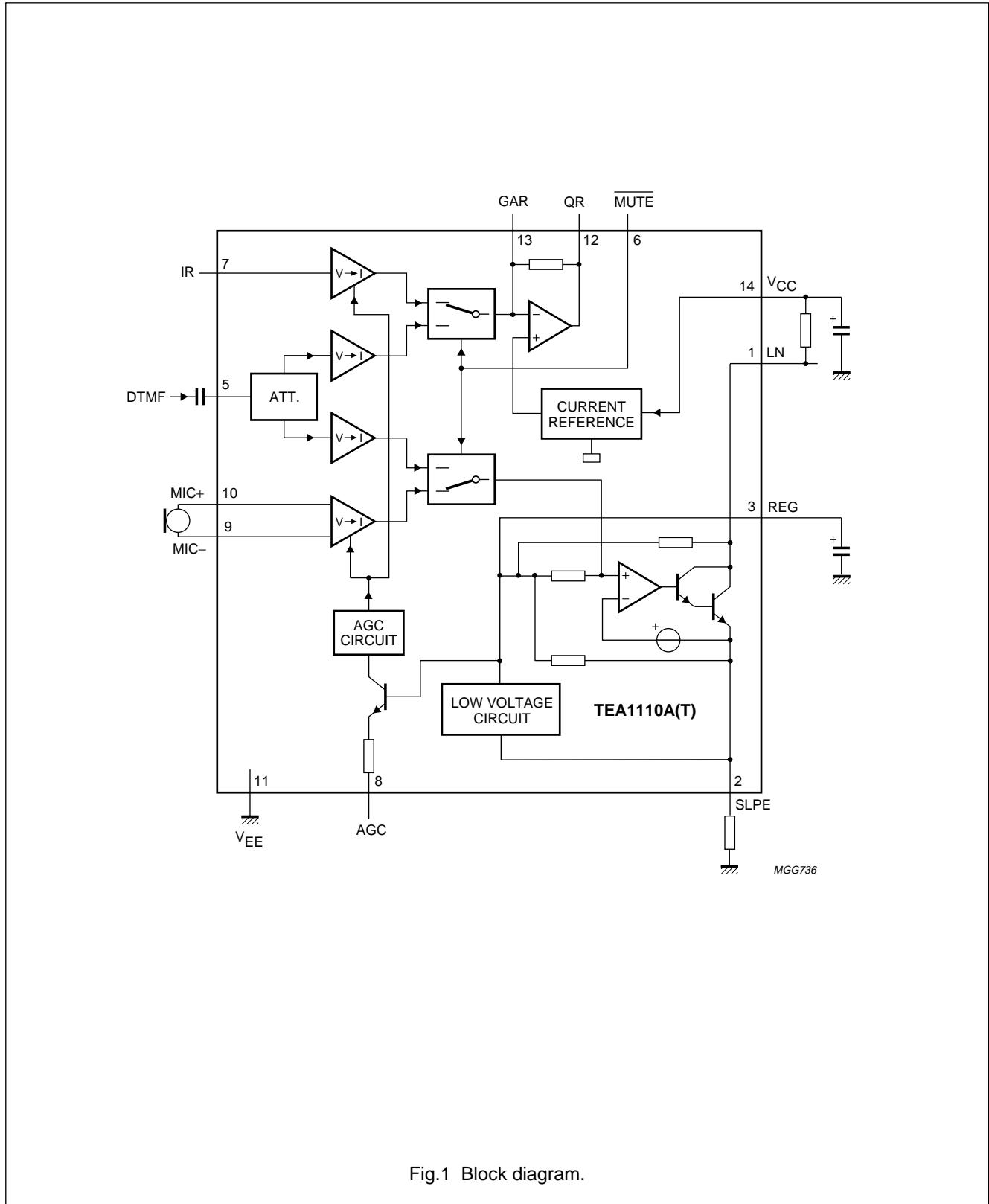

Fig.1 Block diagram.

Low voltage versatile telephone transmission circuit with dialler interface

TEA1110A

PINNING

SYMBOL	PIN	DESCRIPTION
LN	1	positive line terminal
SLPE	2	slope (DC resistance) adjustment
REG	3	line voltage regulator decoupling
n.c.	4	not connected
DTMF	5	dual-tone multi-frequency input
MUTE	6	mute input to select speech or dialling mode (active LOW)
IR	7	receiving amplifier input
AGC	8	automatic gain control/line loss compensation
MIC-	9	inverting microphone amplifier input
MIC+	10	non-inverting microphone amplifier input
V _{EE}	11	negative line terminal
QR	12	receiving amplifier output
GAR	13	receive gain adjustment
V _{CC}	14	supply voltage for speech circuit and peripherals

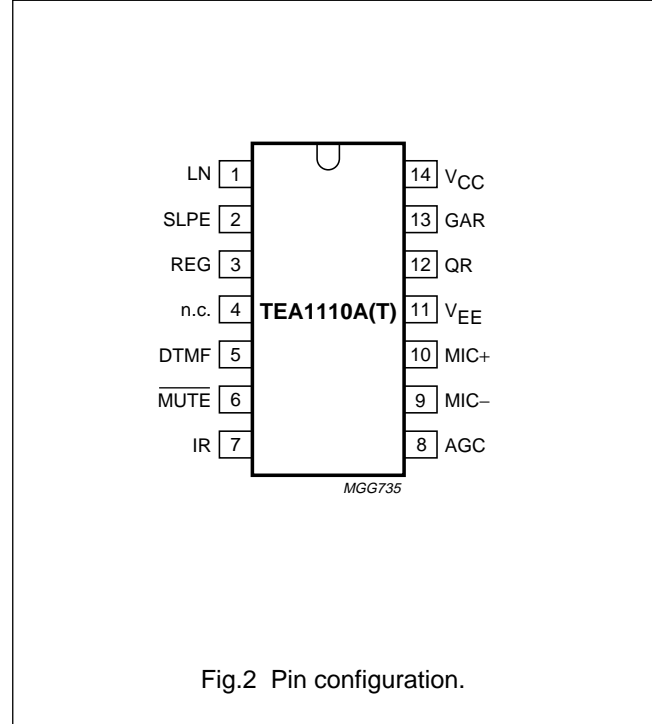

Fig.2 Pin configuration.

FUNCTIONAL DESCRIPTION

All data given in this chapter are typical values, except when otherwise specified.

Supply (pins LN, SLPE, V_{CC} and REG)

The supply for the TEA1110A and its peripherals is obtained from the telephone line. See Fig.3.

The IC generates a stabilized reference voltage (V_{ref}) between pins LN and SLPE. V_{ref} is temperature compensated and can be adjusted by means of an external resistor (R_{VA}). V_{ref} equals 3.35 V and can be increased by connecting R_{VA} between pins REG and SLPE (see Fig.4), or decreased by connecting R_{VA} between pins REG and LN. The voltage at pin REG is used by the internal regulator to generate V_{ref} and is decoupled by C_{REG} , which is connected to V_{EE} . This capacitor, converted into an equivalent inductance (see Section "Set impedance"), realizes the set impedance conversion from its DC value (R_{SLPE}) to its AC value (R_{CC} in the audio-frequency range). The voltage at pin SLPE is proportional to the line current.

The voltage at pin LN is:

$$V_{LN} = V_{ref} + R_{SLPE} \times I_{SLPE}$$

$$I_{SLPE} = I_{line} - I_{CC} - I_P - I^*$$

Where:

I_{line} = line current

I_{CC} = current consumption of the IC

I_P = supply current for peripheral circuits

I^* = current consumed between LN and V_{EE} .

The preferred value for R_{SLPE} is 20 Ω . Changing R_{SLPE} will affect more than the DC characteristics; it also influences the microphone and DTMF gains, the gain control characteristics, the sidetone level and the maximum output swing on the line.

Low voltage versatile telephone transmission circuit with dialler interface

TEA1110A

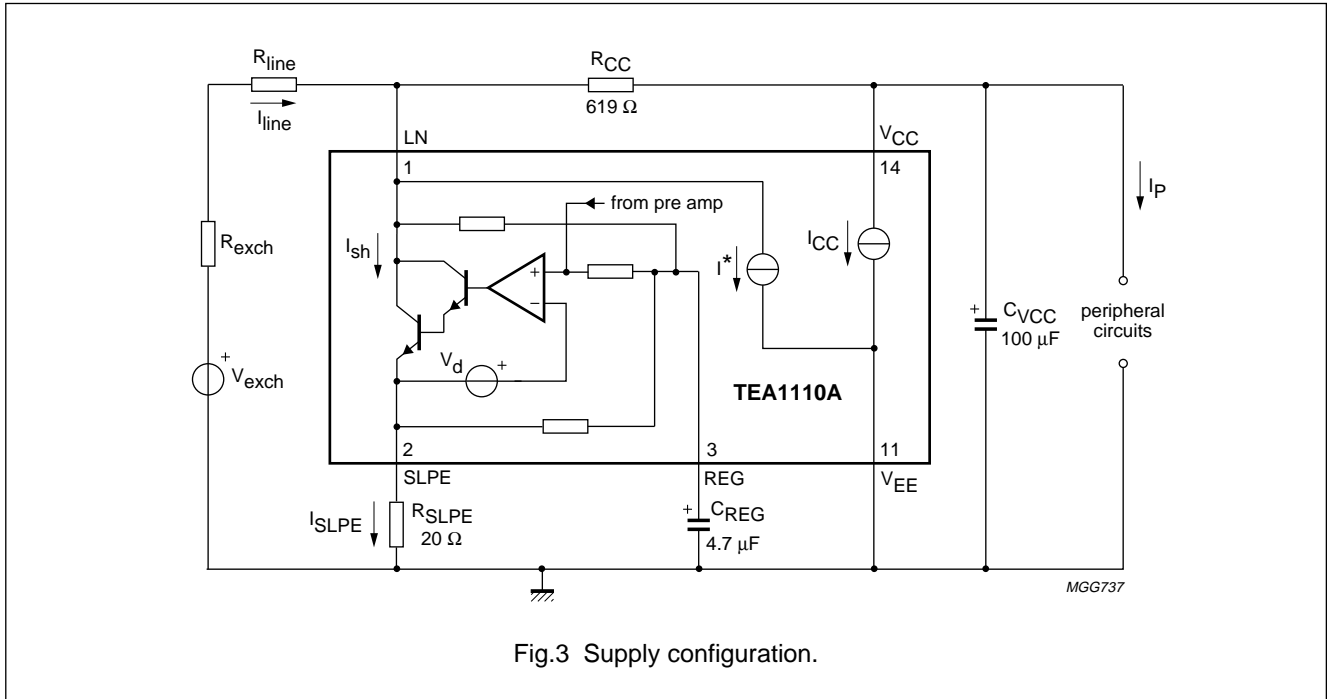

Fig.3 Supply configuration.

The internal circuitry of the TEA1110A is supplied from pin V_{CC}. This voltage supply is derived from the line voltage by means of a resistor (R_{CC}) and must be decoupled by a capacitor C_{VCC}. It may also be used to supply peripheral circuits such as dialling or control circuits. The V_{CC} voltage depends on the current consumed by the IC and the peripheral circuits as shown by the formula:

$$V_{CC} = V_{CC0} - R_{CCint} \times (I_P - I_{rec})$$

$$V_{CC0} = V_{LN} - R_{CC} \times I_{CC} \text{ (see also Figs 5 and 6).}$$

R_{CCint} is the internal equivalent resistance of the voltage supply, and I_{rec} is the current consumed by the output stage of the earpiece amplifier.

The DC line current flowing into the set is determined by the exchange supply voltage (V_{exch}), the feeding bridge resistance (R_{exch}), the DC resistance of the telephone line (R_{line}) and the reference voltage (V_{ref}). With line currents below 7.5 mA, the internal reference voltage (generating V_{ref}) is automatically adjusted to a lower value. This means that more sets can operate in parallel with DC line voltages (excluding the polarity guard) down to an absolute minimum voltage of 1.6 V. At currents below 7.5 mA, the circuit has limited sending and receiving levels. This is called the low voltage area.

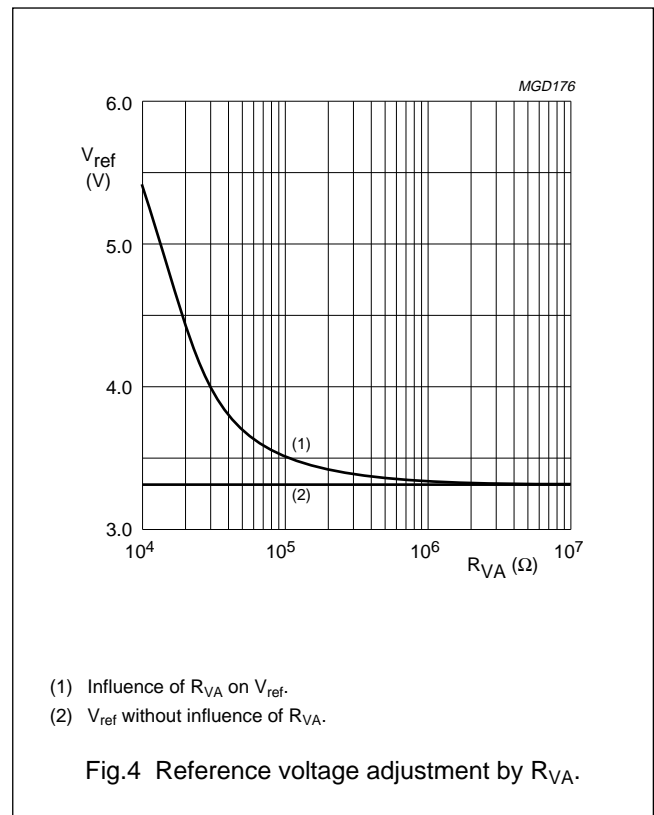

- (1) Influence of R_{VA} on V_{ref}.
- (2) V_{ref} without influence of R_{VA}.

Fig.4 Reference voltage adjustment by R_{VA}.

Low voltage versatile telephone transmission circuit with dialler interface

TEA1110A

Set impedance

In the audio frequency range, the dynamic impedance is mainly determined by the R_{CC} resistor. The equivalent impedance of the circuit is illustrated in Fig.7.

Microphone amplifier (pins MIC+ and MIC-)

The TEA1110A has symmetrical microphone inputs. The input impedance between pins MIC+ and MIC- is 64 k Ω (2×32 k Ω). The voltage gain from pins MIC+/MIC- to pin LN is set at 43.7 dB (typ).

Automatic gain control is provided on this amplifier for line loss compensation.

Receiving amplifier (pins IR, GAR and QR)

The receiving amplifier has one input (IR) and one output (QR). The input impedance between pin IR and pin V_{EE} is 20 k Ω . The voltage gain from pin IR to pin QR is set at 33 dB (typ). The gain can be decreased by connecting an external resistor R_{GAR} between pins GAR and QR; the adjustment range is 14 dB. Two external capacitors C_{GAR} (connected between GAR and QR) and C_{GARS} (connected between GAR and V_{EE}) ensure stability. The C_{GAR} capacitor provides a first-order low-pass filter. The cut-off frequency corresponds to the time constant $C_{GAR} \times (R_{GARint} // R_{GAR})$. R_{GARint} is the internal resistor which sets the gain with a typical value of 125 k Ω . The condition $C_{GARS} = 10 \times C_{GAR}$ must be fulfilled to ensure stability.

The output voltage of the receiving amplifier is specified for continuous wave drive. The maximum output swing depends on the DC line voltage, the R_{CC} resistor, the I_{CC} current consumption of the circuit, the I_P current consumption of the peripheral circuits and the load impedance.

Automatic gain control is provided on this amplifier for line loss compensation.

Automatic gain control (pin AGC)

The TEA1110A performs automatic line loss compensation. The automatic gain control varies the gain of the microphone amplifier and the gain of the receiving amplifier in accordance with the DC line current. The control range is 5.9 dB (which corresponds approximately to a line length of 5 km for a 0.5 mm diameter twisted-pair copper cable with a DC resistance of 176 Ω /km and an average attenuation of 1.2 dB/km). The IC can be used with different configurations of feeding bridge (supply voltage and bridge resistance) by connecting an external resistor R_{AGC} between pins AGC

and V_{EE} . This resistor enables the I_{start} and I_{stop} line currents to be increased (the ratio between I_{start} and I_{stop} is not affected by the resistor). The AGC function is disabled when pin AGC is left open-circuit.

Mute function (pin \overline{MUTE})

The mute function performs the switching between the speech mode and the dialling mode. When \overline{MUTE} is LOW, the DTMF input is enabled and the microphone and receiving amplifiers inputs are disabled. When \overline{MUTE} is HIGH, the microphone and receiving amplifiers inputs are enabled while the DTMF input is disabled. A pull-up resistor is included at the input.

DTMF amplifier (pin DTMF)

When the DTMF amplifier is enabled, dialling tones may be sent on line. These tones can be heard in the earpiece at a low level (confidence tone).

The TEA1110A has an asymmetrical DTMF input. The input impedance between DTMF and V_{EE} is 20 k Ω . The voltage gain from pin DTMF to pin LN is 25.3 dB.

The automatic gain control has no effect on the DTMF amplifier.

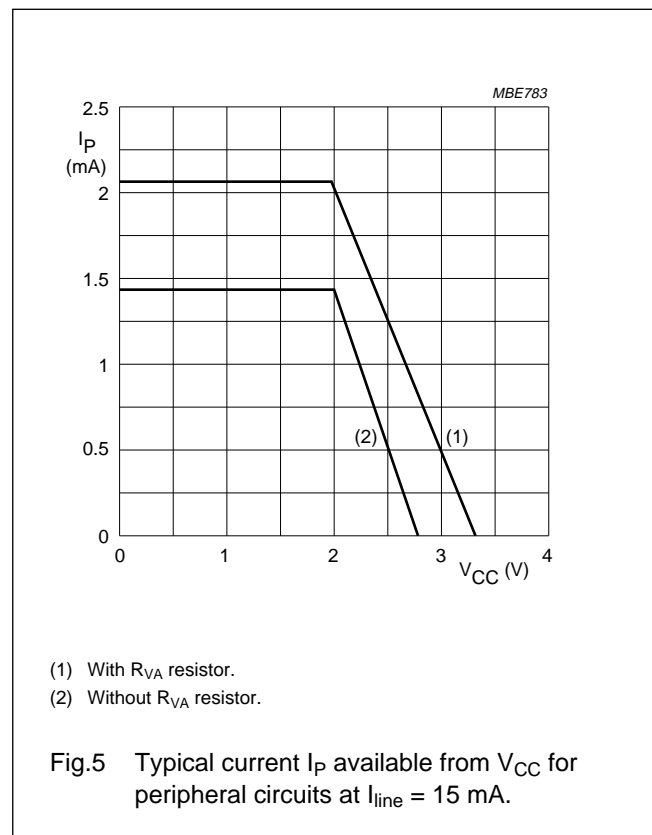

Low voltage versatile telephone transmission circuit with dialler interface

TEA1110A

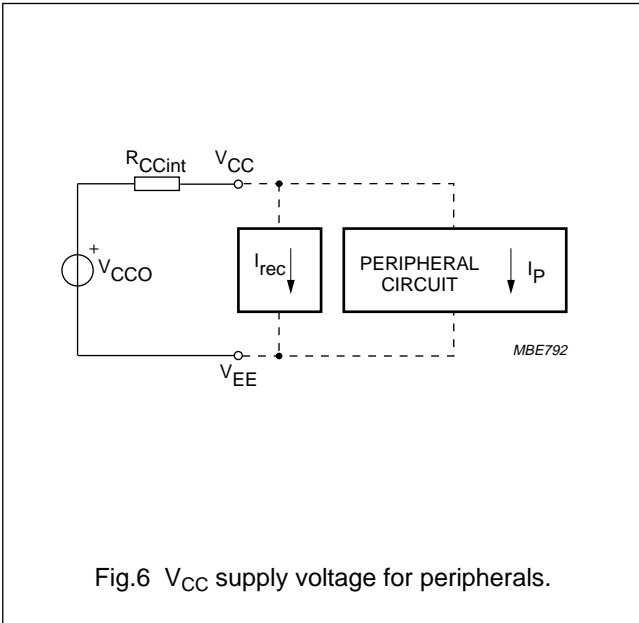

Fig.6 V_{CC} supply voltage for peripherals.

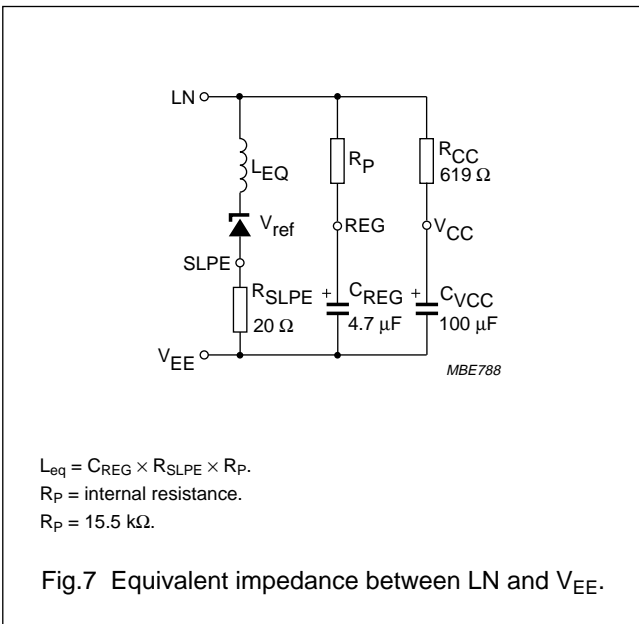

Fig.7 Equivalent impedance between LN and V_{EE}.

SIDETONE SUPPRESSION

The TEA1110A anti-sidetone network comprising R_{CC}/Z_{line} , R_{ast1} , R_{ast2} , R_{ast3} , R_{SLPE} and Z_{bal} (see Fig.8) suppresses the transmitted signal in the earpiece. Maximum compensation is obtained when the following conditions are fulfilled:

$$R_{SLPE} \times R_{ast1} = R_{CC} \times (R_{ast2} + R_{ast3})$$

$$k = \frac{(R_{ast2} \times (R_{ast3} + R_{SLPE}))}{(R_{ast1} \times R_{SLPE})}$$

$$Z_{bal} = k \times Z_{line}$$

The scale factor k is chosen to meet the compatibility with a standard capacitor from the E6 or E12 range for Z_{bal} .

In practice, Z_{line} varies considerably with the line type and the line length. Therefore, the value of Z_{bal} should be for an average line length which gives satisfactory sidetone suppression with short and long lines. The suppression also depends on the accuracy of the match between Z_{bal} and the impedance of the average line.

The anti-sidetone network for the TEA1110A (as shown in Fig.12) attenuates the receiving signal from the line by 32 dB before it enters the receiving amplifier.

The attenuation is almost constant over the whole audio frequency range.

A Wheatstone bridge configuration (see Fig.9) may also be used.

More information on the balancing of an anti-sidetone bridge can be obtained in our publication "Applications Handbook for Wired Telecom Systems, IC03b", order number 9397 750 00811.

Low voltage versatile telephone transmission circuit with dialler interface

TEA1110A

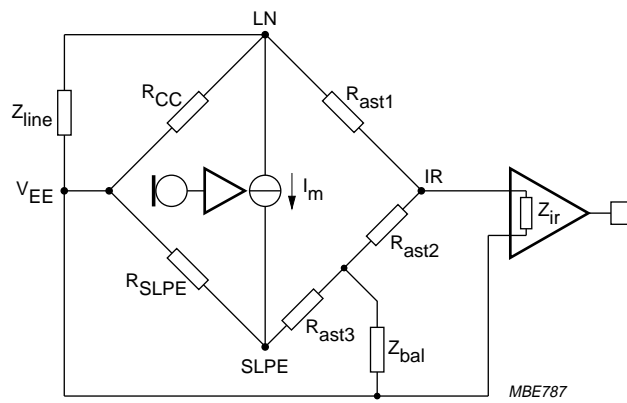

Fig.8 Equivalent circuit of TEA1110A family anti-sidetone bridge.

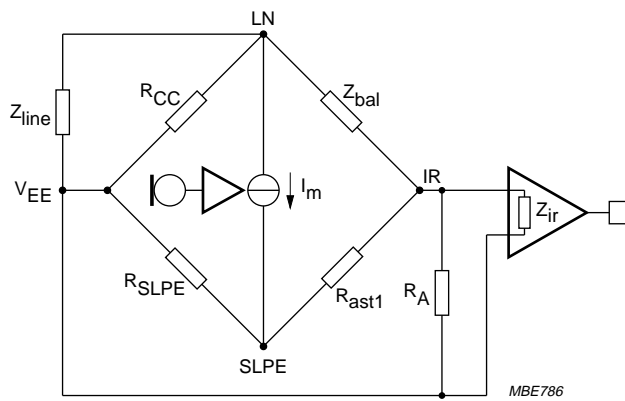

Fig.9 Equivalent circuit of an anti-sidetone network in a Wheatstone bridge configuration.

Low voltage versatile telephone transmission circuit with dialler interface

TEA1110A

LIMITING VALUES

In accordance with the Absolute Maximum Rating System (IEC 134).

SYMBOL	PARAMETER	CONDITIONS	MIN.	MAX.	UNIT
V_{LN}	positive continuous line voltage		$V_{EE} - 0.4$	12	V
	repetitive line voltage during switch-on or line interruption		$V_{EE} - 0.4$	13.2	V
$V_{n(max)}$	maximum voltage on all pins		$V_{EE} - 0.4$	$V_{CC} + 0.4$	V
I_{line}	line current	$R_{SLPE} = 20 \Omega$; see Figs 10 and 11	–	140	mA
P_{tot}	total power dissipation TEA1110A	$T_{amb} = 75 \text{ }^\circ\text{C}$; see Figs 10 and 11	–	588	mW
	TEA1110AT		–	384	mW
T_{stg}	storage temperature		–40	+125	$^\circ\text{C}$
T_{amb}	operating ambient temperature		–25	+75	$^\circ\text{C}$

HANDLING

This device meets class 2 ESD test requirements [Human Body Model (HBM)], in accordance with "MIL STD 883C - method 3015".

THERMAL CHARACTERISTICS

SYMBOL	PARAMETER	VALUE	UNIT
$R_{th\ j-a}$	thermal resistance from junction to ambient in free air; mounted on epoxy board $40.1 \times 19.1 \times 1.5$ mm (TEA1110A)	85	K/W
	thermal resistance from junction to ambient in free air; mounted on epoxy board $40.1 \times 19.1 \times 1.5$ mm (TEA1110AT)	130	K/W

Low voltage versatile telephone transmission circuit with dialler interface

TEA1110A

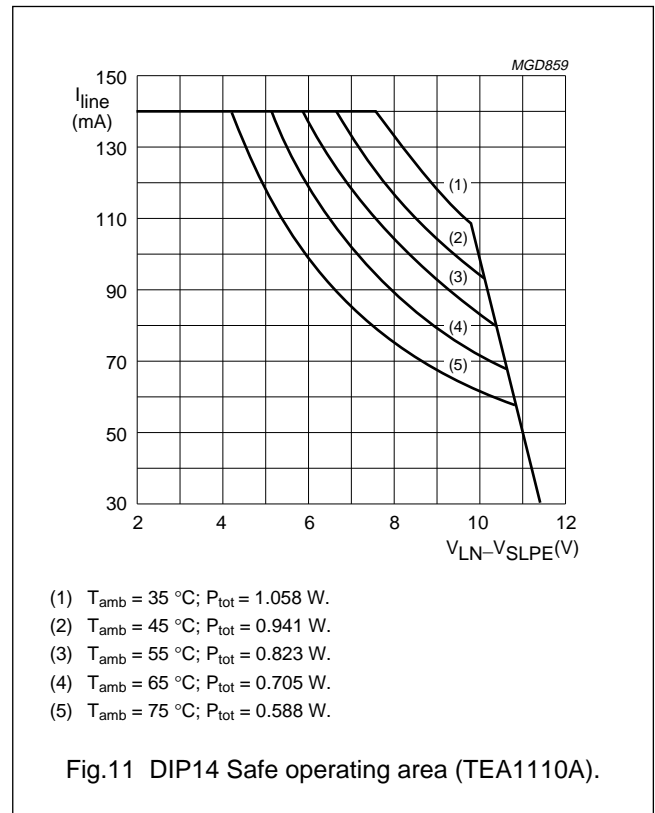
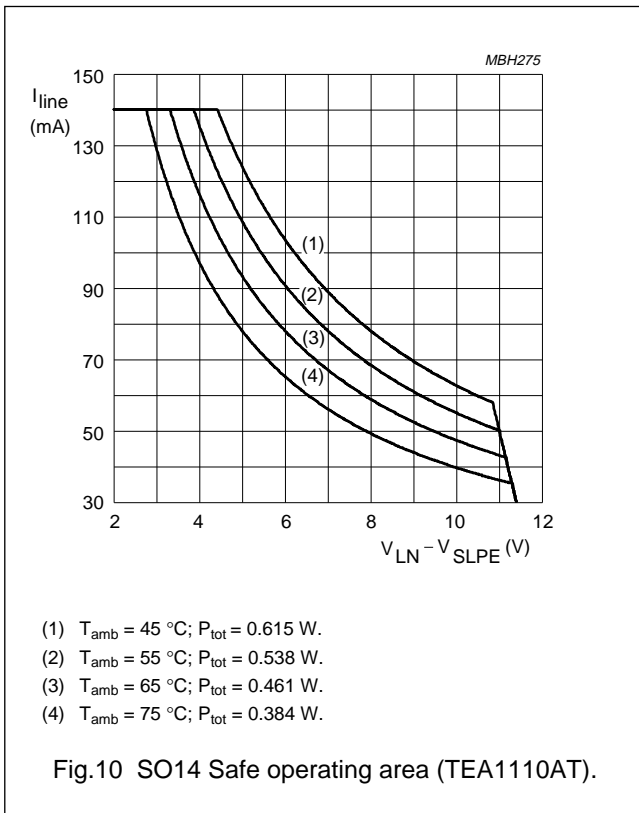

Low voltage versatile telephone transmission circuit with dialler interface

TEA1110A

CHARACTERISTICS

$I_{line} = 15 \text{ mA}$; $V_{EE} = 0 \text{ V}$; $R_{SLPE} = 20 \text{ }\Omega$; AGC pin connected to V_{EE} ; $Z_{line} = 600 \text{ }\Omega$; $f = 1 \text{ kHz}$; $T_{amb} = 25 \text{ }^\circ\text{C}$;
unless otherwise specified.

SYMBOL	PARAMETER	CONDITIONS	MIN.	TYP.	MAX.	UNIT
Supplies (pins V_{LN}, V_{CC}, SLPE and REG)						
V_{ref}	stabilized voltage between LN and SLPE		3.1	3.35	3.6	V
V_{LN}	DC line voltage	$I_{line} = 1 \text{ mA}$	–	1.6	–	V
		$I_{line} = 4 \text{ mA}$	–	2.3	–	V
		$I_{line} = 15 \text{ mA}$	3.35	3.65	3.95	V
		$I_{line} = 140 \text{ mA}$	–	–	6.9	V
$V_{LN(exR)}$	DC line voltage with an external resistor R_{VA}	$R_{VA(SLPE-REG)} = 27 \text{ k}\Omega$	–	4.4	–	V
$\Delta V_{LN(T)}$	DC line voltage variation with temperature referred to $25 \text{ }^\circ\text{C}$	$T_{amb} = -25 \text{ to } +75 \text{ }^\circ\text{C}$	–	± 30	–	mV
I_{CC}	internal current consumption	$V_{CC} = 2.9 \text{ V}$	–	1.1	1.4	mA
V_{CC}	supply voltage for peripherals	$I_P = 0 \text{ mA}$	–	2.9	–	V
R_{CCint}	equivalent supply voltage resistance	$I_P = 0.5 \text{ mA}$	–	550	620	Ω
Microphone amplifier (pins MIC+ and MIC–)						
$ Z_i $	input impedance					
	differential between pins MIC+ and MIC–		–	64	–	k Ω
	single-ended between pins MIC+/MIC– and V_{EE}		–	32	–	k Ω
G_{vtx}	voltage gain from MIC+/MIC– to LN	$V_{MIC} = 4 \text{ mV (RMS)}$	42.7	43.7	44.7	dB
$\Delta G_{vtx(f)}$	gain variation with frequency referred to 1 kHz	$f = 300 \text{ to } 3400 \text{ Hz}$	–	± 0.2	–	dB
$\Delta G_{vtx(T)}$	gain variation with temperature referred to $25 \text{ }^\circ\text{C}$	$T_{amb} = -25 \text{ to } +75 \text{ }^\circ\text{C}$	–	± 0.3	–	dB
CMRR	common mode rejection ratio		–	80	–	dB
$V_{LN(max)(rms)}$	maximum sending signal (RMS value)	$I_{line} = 15 \text{ mA}$; THD = 2%	1.4	1.7	–	V
		$I_{line} = 4 \text{ mA}$, THD = 10%	–	0.8	–	V
V_{notx}	noise output voltage at pin LN; pins MIC+/MIC– shorted through $200 \text{ }\Omega$	psophometrically weighted (P53 curve)	–	–78.5	–	dBmp
Receiving amplifier (pins IR, QR and GAR)						
$ Z_i $	input impedance		–	20	–	k Ω
G_{vrx}	voltage gain from IR to QR	$V_{IR} = 4 \text{ mV (RMS)}$	32	33	34	dB
$\Delta G_{vrx(f)}$	gain variation with frequency referred to 1 kHz	$f = 300 \text{ to } 3400 \text{ Hz}$	–	± 0.2	–	dB
$\Delta G_{vrx(T)}$	gain variation with temperature referred to $25 \text{ }^\circ\text{C}$	$T_{amb} = -25 \text{ to } +75 \text{ }^\circ\text{C}$	–	± 0.3	–	dB

Low voltage versatile telephone transmission circuit with dialler interface

TEA1110A

SYMBOL	PARAMETER	CONDITIONS	MIN.	TYP.	MAX.	UNIT
ΔG_{vrxr}	gain voltage reduction range	external resistor connected between GAR and QR	–	–	14	dB
$V_{o(rms)}$	maximum receiving signal (RMS value)	$I_P = 0$ mA sine wave drive; $R_L = 150 \Omega$; THD = 2%	–	0.25	–	V
		$I_P = 0$ mA sine wave drive; $R_L = 450 \Omega$; THD = 2%	–	0.35	–	V
$V_{norx(rms)}$	noise output voltage at pin QR (RMS value)	$G_{vrx} = 33$ dB; IR open-circuit; $R_L = 150 \Omega$; psophometrically weighted (P53 curve)	–	–87	–	dBVp
Automatic gain control (pin AGC)						
ΔG_{vtrx}	gain control range for microphone and receiving amplifiers with respect to $I_{line} = 15$ mA	$I_{line} = 85$ mA	–	5.9	–	dB
I_{start}	highest line current for maximum gain		–	23	–	mA
I_{stop}	lowest line current for minimum gain		–	56	–	mA
DTMF amplifier (pin DTMF)						
$ Z_i $	input impedance		–	20	–	k Ω
G_{vdtmf}	voltage gain from DTMF to LN	$V_{DTMF} = 20$ mV (RMS); MUTE = LOW	24.1	25.3	26.5	dB
$\Delta G_{vdtmf(f)}$	gain variation with frequency referred to 1 kHz	$f = 300$ to 3400 Hz	–	± 0.2	–	dB
$\Delta G_{vdtmf(T)}$	gain variation with temperature referred to 25 °C	$T_{amb} = -25$ to +75 °C	–	± 0.4	–	dB
G_{vct}	voltage gain from DTMF to QR (confidence tone)	$V_{DTMF} = 20$ mV (RMS); $R_L = 150 \Omega$	–	–15	–	dB
Mute function (pin MUTE)						
V_{IL}	LOW level input voltage		$V_{EE} - 0.4$	–	$V_{EE} + 0.3$	V
V_{IH}	HIGH level input voltage		$V_{EE} + 1.5$	–	$V_{CC} + 0.4$	V
I_{MUTE}	input current			1.5		μ A
ΔG_{vtrxm}	gain reduction for microphone and receiving amplifiers	MUTE = LOW		80		dB

Low voltage versatile telephone transmission circuit with dialler interface

TEA110A

APPLICATION INFORMATION

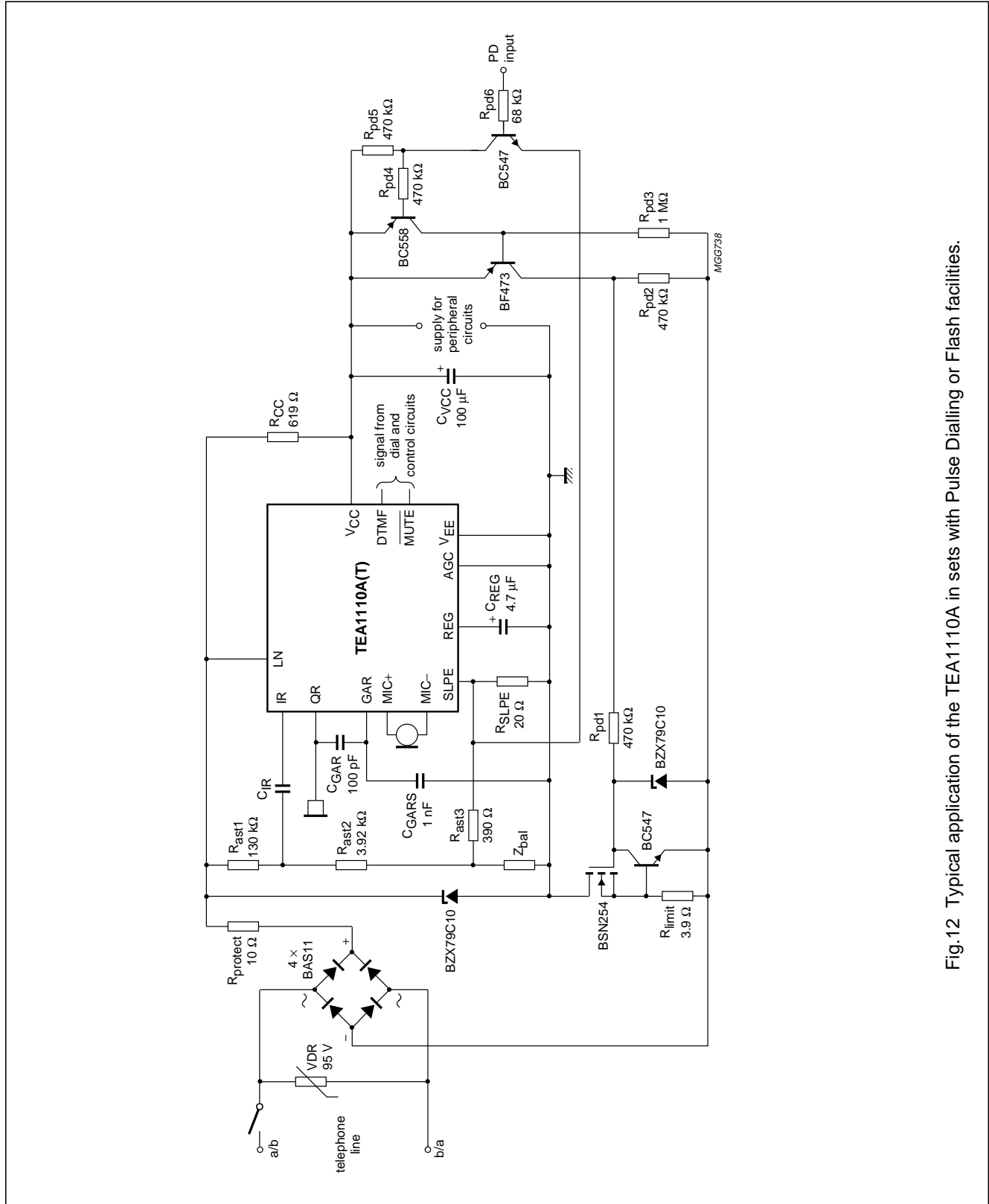

Fig.12 Typical application of the TEA110A in sets with Pulse Dialling or Flash facilities.

Low voltage versatile telephone transmission circuit with dialler interface

TEA1110A

PACKAGE OUTLINES

SO14: plastic small outline package; 14 leads; body width 3.9 mm

SOT108-1

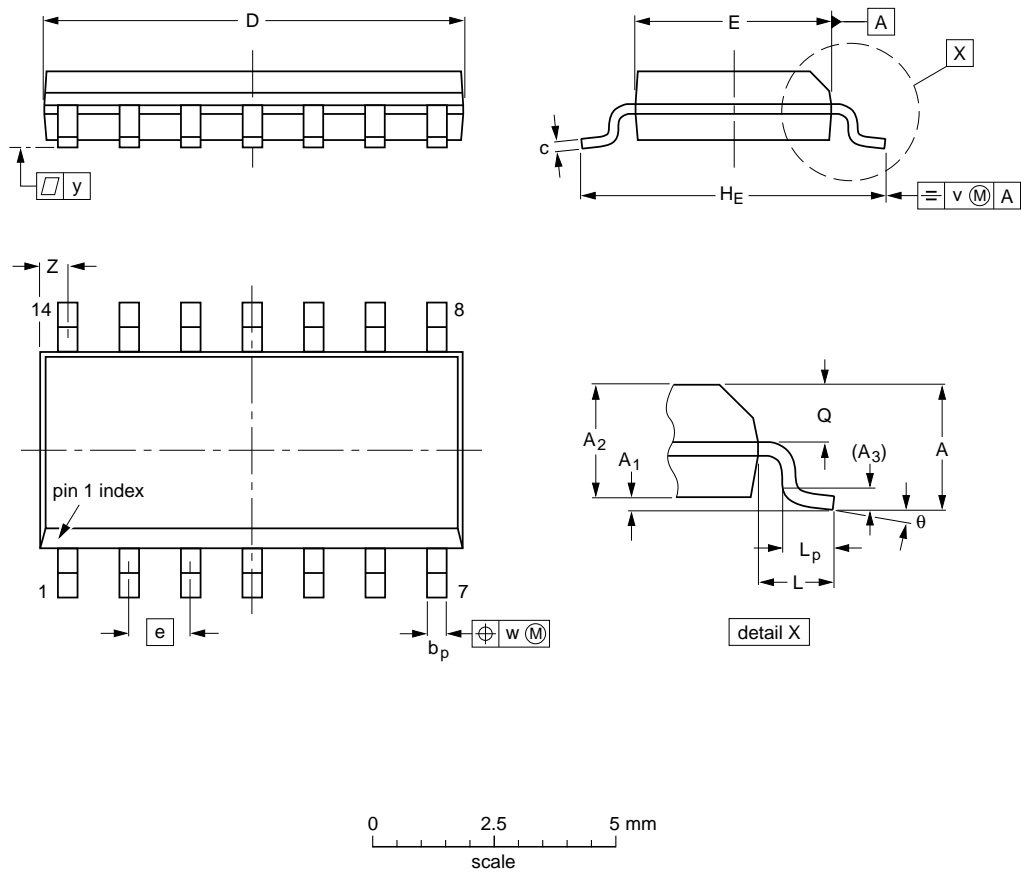

DIMENSIONS (inch dimensions are derived from the original mm dimensions)

UNIT	A max.	A ₁	A ₂	A ₃	b _p	c	D ⁽¹⁾	E ⁽¹⁾	e	H _E	L	L _p	Q	v	w	y	Z ⁽¹⁾	θ
mm	1.75	0.25 0.10	1.45 1.25	0.25	0.49 0.36	0.25 0.19	8.75 8.55	4.0 3.8	1.27	6.2 5.8	1.05	1.0 0.4	0.7 0.6	0.25	0.25	0.1	0.7 0.3	8° 0°
inches	0.069	0.0098 0.0039	0.057 0.049	0.01	0.019 0.014	0.0098 0.0075	0.35 0.34	0.16 0.15	0.050	0.24 0.23	0.041	0.039 0.016	0.028 0.024	0.01	0.01	0.004	0.028 0.012	

Note

1. Plastic or metal protrusions of 0.15 mm maximum per side are not included.

OUTLINE VERSION	REFERENCES				EUROPEAN PROJECTION	ISSUE DATE
	IEC	JEDEC	EIAJ			
SOT108-1	076E06S	MS-012AB				91-08-13 95-01-23

Low voltage versatile telephone
transmission circuit with dialler interface

TEA1110A

DIP14: plastic dual in-line package; 14 leads (300 mil)

SOT27-1

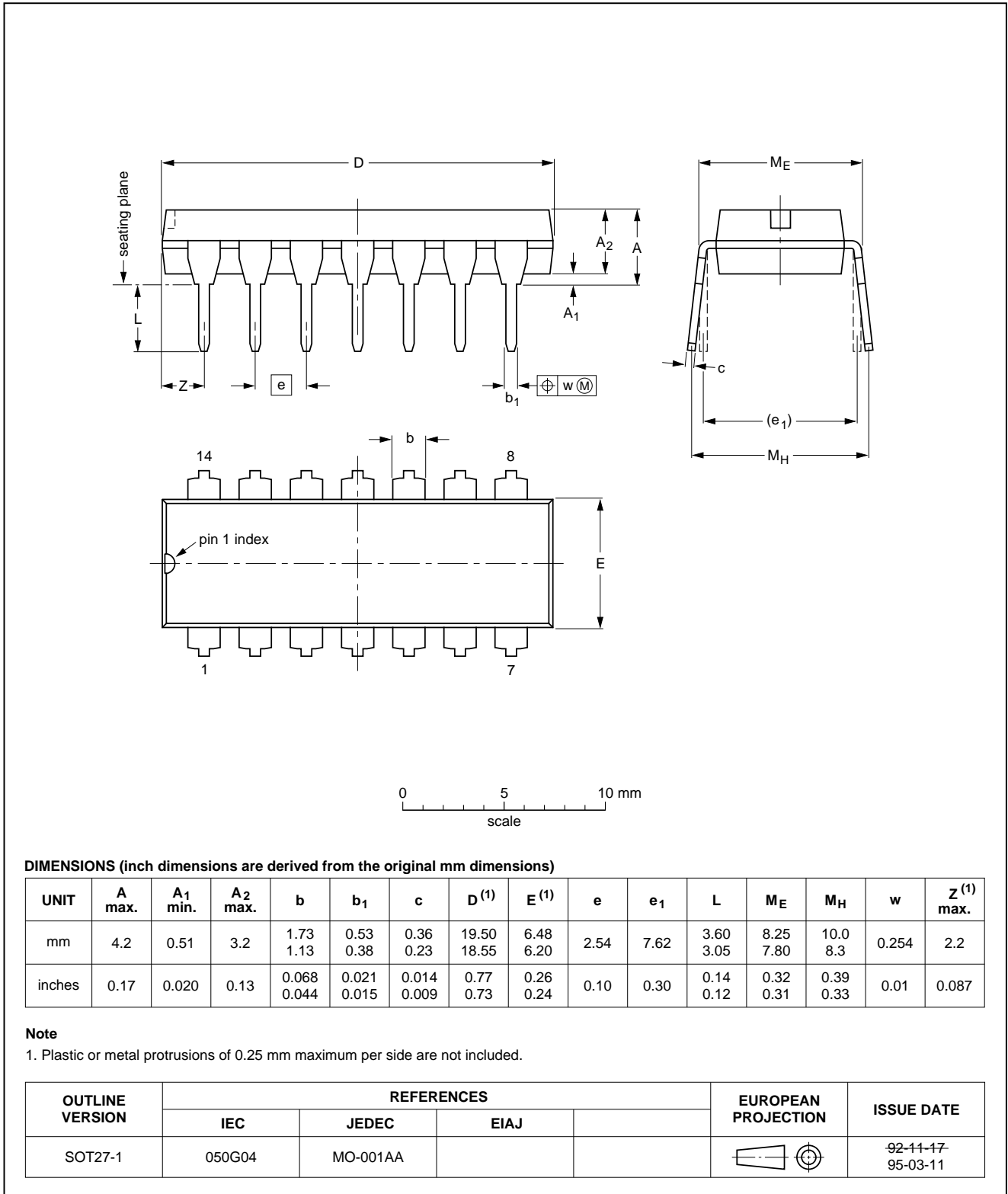

Low voltage versatile telephone transmission circuit with dialler interface

TEA1110A

SOLDERING

Introduction

There is no soldering method that is ideal for all IC packages. Wave soldering is often preferred when through-hole and surface mounted components are mixed on one printed-circuit board. However, wave soldering is not always suitable for surface mounted ICs, or for printed-circuits with high population densities. In these situations reflow soldering is often used.

This text gives a very brief insight to a complex technology. A more in-depth account of soldering ICs can be found in our "IC Package Databook" (order code 9398 652 90011).

DIP

SOLDERING BY DIPPING OR BY WAVE

The maximum permissible temperature of the solder is 260 °C; solder at this temperature must not be in contact with the joint for more than 5 seconds. The total contact time of successive solder waves must not exceed 5 seconds.

The device may be mounted up to the seating plane, but the temperature of the plastic body must not exceed the specified maximum storage temperature ($T_{stg\ max}$). If the printed-circuit board has been pre-heated, forced cooling may be necessary immediately after soldering to keep the temperature within the permissible limit.

REPAIRING SOLDERED JOINTS

Apply a low voltage soldering iron (less than 24 V) to the lead(s) of the package, below the seating plane or not more than 2 mm above it. If the temperature of the soldering iron bit is less than 300 °C it may remain in contact for up to 10 seconds. If the bit temperature is between 300 and 400 °C, contact may be up to 5 seconds.

SO

REFLOW SOLDERING

Reflow soldering techniques are suitable for all SO packages.

Reflow soldering requires solder paste (a suspension of fine solder particles, flux and binding agent) to be applied to the printed-circuit board by screen printing, stencilling or pressure-syringe dispensing before package placement.

Several techniques exist for reflowing; for example, thermal conduction by heated belt. Dwell times vary between 50 and 300 seconds depending on heating method. Typical reflow temperatures range from 215 to 250 °C.

Preheating is necessary to dry the paste and evaporate the binding agent. Preheating duration: 45 minutes at 45 °C.

WAVE SOLDERING

Wave soldering techniques can be used for all SO packages if the following conditions are observed:

- A double-wave (a turbulent wave with high upward pressure followed by a smooth laminar wave) soldering technique should be used.
- The longitudinal axis of the package footprint must be parallel to the solder flow.
- The package footprint must incorporate solder thieves at the downstream end.

During placement and before soldering, the package must be fixed with a droplet of adhesive. The adhesive can be applied by screen printing, pin transfer or syringe dispensing. The package can be soldered after the adhesive is cured.

Maximum permissible solder temperature is 260 °C, and maximum duration of package immersion in solder is 10 seconds, if cooled to less than 150 °C within 6 seconds. Typical dwell time is 4 seconds at 250 °C.

A mildly-activated flux will eliminate the need for removal of corrosive residues in most applications.

REPAIRING SOLDERED JOINTS

Fix the component by first soldering two diagonally-opposite end leads. Use only a low voltage soldering iron (less than 24 V) applied to the flat part of the lead. Contact time must be limited to 10 seconds at up to 300 °C. When using a dedicated tool, all other leads can be soldered in one operation within 2 to 5 seconds between 270 and 320 °C.

Low voltage versatile telephone transmission circuit with dialler interface

TEA1110A

DEFINITIONS

Data sheet status	
Objective specification	This data sheet contains target or goal specifications for product development.
Preliminary specification	This data sheet contains preliminary data; supplementary data may be published later.
Product specification	This data sheet contains final product specifications.
Limiting values	
Limiting values given are in accordance with the Absolute Maximum Rating System (IEC 134). Stress above one or more of the limiting values may cause permanent damage to the device. These are stress ratings only and operation of the device at these or at any other conditions above those given in the Characteristics sections of the specification is not implied. Exposure to limiting values for extended periods may affect device reliability.	
Application information	
Where application information is given, it is advisory and does not form part of the specification.	

LIFE SUPPORT APPLICATIONS

These products are not designed for use in life support appliances, devices, or systems where malfunction of these products can reasonably be expected to result in personal injury. Philips customers using or selling these products for use in such applications do so at their own risk and agree to fully indemnify Philips for any damages resulting from such improper use or sale.

Low voltage versatile telephone
transmission circuit with dialler interface

TEA1110A

NOTES

Low voltage versatile telephone
transmission circuit with dialler interface

TEA1110A

NOTES

Philips Semiconductors – a worldwide company

Argentina: see South America

Australia: 34 Waterloo Road, NORTH RYDE, NSW 2113,
Tel. +61 2 9805 4455, Fax. +61 2 9805 4466

Austria: Computerstr. 6, A-1101 WIEN, P.O. Box 213,
Tel. +43 1 60 101, Fax. +43 1 60 101 1210

Belarus: Hotel Minsk Business Center, Bld. 3, r. 1211, Volodarski Str. 6,
220050 MINSK, Tel. +375 172 200 733, Fax. +375 172 200 773

Belgium: see The Netherlands

Brazil: see South America

Bulgaria: Philips Bulgaria Ltd., Energoproject, 15th floor,
51 James Bourchier Blvd., 1407 SOFIA,
Tel. +359 2 689 211, Fax. +359 2 689 102

Canada: PHILIPS SEMICONDUCTORS/COMPONENTS,
Tel. +1 800 234 7381

China/Hong Kong: 501 Hong Kong Industrial Technology Centre,
72 Tat Chee Avenue, Kowloon Tong, HONG KONG,
Tel. +852 2319 7888, Fax. +852 2319 7700

Colombia: see South America

Czech Republic: see Austria

Denmark: Prags Boulevard 80, PB 1919, DK-2300 COPENHAGEN S,
Tel. +45 32 88 2636, Fax. +45 31 57 0044

Finland: Sinikalliontie 3, FIN-02630 ESPOO,
Tel. +358 9 615800, Fax. +358 9 61580920

France: 4 Rue du Port-aux-Vins, BP317, 92156 SURESNES Cedex,
Tel. +33 1 40 99 6161, Fax. +33 1 40 99 6427

Germany: Hammerbrookstraße 69, D-20097 HAMBURG,
Tel. +49 40 23 53 60, Fax. +49 40 23 536 300

Greece: No. 15, 25th March Street, GR 17778 TAVROS/ATHENS,
Tel. +30 1 4894 339/239, Fax. +30 1 4814 240

Hungary: see Austria

India: Philips INDIA Ltd, Shivsagar Estate, A Block, Dr. Annie Besant Rd.
Worli, MUMBAI 400 018, Tel. +91 22 4938 541, Fax. +91 22 4938 722

Indonesia: see Singapore

Ireland: Newstead, Clonskeagh, DUBLIN 14,
Tel. +353 1 7640 000, Fax. +353 1 7640 200

Israel: RAPAC Electronics, 7 Kehilat Saloniki St, PO Box 18053,
TEL AVIV 61180, Tel. +972 3 645 0444, Fax. +972 3 649 1007

Italy: PHILIPS SEMICONDUCTORS, Piazza IV Novembre 3,
20124 MILANO, Tel. +39 2 6752 2531, Fax. +39 2 6752 2557

Japan: Philips Bldg 13-37, Kohnan 2-chome, Minato-ku, TOKYO 108,
Tel. +81 3 3740 5130, Fax. +81 3 3740 5077

Korea: Philips House, 260-199 Itaewon-dong, Yongsan-ku, SEOUL,
Tel. +82 2 709 1412, Fax. +82 2 709 1415

Malaysia: No. 76 Jalan Universiti, 46200 PETALING JAYA, SELANGOR,
Tel. +60 3 750 5214, Fax. +60 3 757 4880

Mexico: 5900 Gateway East, Suite 200, EL PASO, TEXAS 79905,
Tel. +9-5 800 234 7381

Middle East: see Italy

Netherlands: Postbus 90050, 5600 PB EINDHOVEN, Bldg. VB,
Tel. +31 40 27 82785, Fax. +31 40 27 88399

New Zealand: 2 Wagener Place, C.P.O. Box 1041, AUCKLAND,
Tel. +64 9 849 4160, Fax. +64 9 849 7811

Norway: Box 1, Manglerud 0612, OSLO,
Tel. +47 22 74 8000, Fax. +47 22 74 8341

Philippines: Philips Semiconductors Philippines Inc.,
106 Valero St. Salcedo Village, P.O. Box 2108 MCC, MAKATI,
Metro MANILA, Tel. +63 2 816 6380, Fax. +63 2 817 3474

Poland: Ul. Lukiska 10, PL 04-123 WARSZAWA,
Tel. +48 22 612 2831, Fax. +48 22 612 2327

Portugal: see Spain

Romania: see Italy

Russia: Philips Russia, Ul. Usatcheva 35A, 119048 MOSCOW,
Tel. +7 095 755 6918, Fax. +7 095 755 6919

Singapore: Lorong 1, Toa Payoh, SINGAPORE 1231,
Tel. +65 350 2538, Fax. +65 251 6500

Slovakia: see Austria

Slovenia: see Italy

South Africa: S.A. PHILIPS Pty Ltd., 195-215 Main Road Martindale,
2092 JOHANNESBURG, P.O. Box 7430 Johannesburg 2000,
Tel. +27 11 470 5911, Fax. +27 11 470 5494

South America: Rua do Rocio 220, 5th floor, Suite 51,
04552-903 São Paulo, SÃO PAULO - SP, Brazil,
Tel. +55 11 821 2333, Fax. +55 11 829 1849

Spain: Balmes 22, 08007 BARCELONA,
Tel. +34 3 301 6312, Fax. +34 3 301 4107

Sweden: Kottbygatan 7, Akalla, S-16485 STOCKHOLM,
Tel. +46 8 632 2000, Fax. +46 8 632 2745

Switzerland: Allmendstrasse 140, CH-8027 ZÜRICH,
Tel. +41 1 488 2686, Fax. +41 1 481 7730

Taiwan: Philips Semiconductors, 6F, No. 96, Chien Kuo N. Rd., Sec. 1,
TAIPEI, Taiwan Tel. +886 2 2134 2865, Fax. +886 2 2134 2874

Thailand: PHILIPS ELECTRONICS (THAILAND) Ltd.,
209/2 Sanpavuth-Bangna Road Prakanong, BANGKOK 10260,
Tel. +66 2 745 4090, Fax. +66 2 398 0793

Turkey: Talatpasa Cad. No. 5, 80640 GÜLTEPE/ISTANBUL,
Tel. +90 212 279 2770, Fax. +90 212 282 6707

Ukraine: PHILIPS UKRAINE, 4 Patrice Lumumba str., Building B, Floor 7,
252042 KIEV, Tel. +380 44 264 2776, Fax. +380 44 268 0461

United Kingdom: Philips Semiconductors Ltd., 276 Bath Road, Hayes,
MIDDLESEX UB3 5BX, Tel. +44 181 730 5000, Fax. +44 181 754 8421

United States: 811 East Arques Avenue, SUNNYVALE, CA 94088-3409,
Tel. +1 800 234 7381

Uruguay: see South America

Vietnam: see Singapore

Yugoslavia: PHILIPS, Trg N. Pasica 5/v, 11000 BEOGRAD,
Tel. +381 11 625 344, Fax. +381 11 635 777

For all other countries apply to: Philips Semiconductors, Marketing & Sales Communications,
Building BE-p, P.O. Box 218, 5600 MD EINDHOVEN, The Netherlands, Fax. +31 40 27 24825

Internet: <http://www.semiconductors.philips.com>

© Philips Electronics N.V. 1997

SCA54

All rights are reserved. Reproduction in whole or in part is prohibited without the prior written consent of the copyright owner.

The information presented in this document does not form part of any quotation or contract, is believed to be accurate and reliable and may be changed without notice. No liability will be accepted by the publisher for any consequence of its use. Publication thereof does not convey nor imply any license under patent- or other industrial or intellectual property rights.

Printed in The Netherlands

417027/1200/02/pp20

Date of release: 1997 Apr 22

Document order number: 9397 750 02077

Let's make things better.

**Philips
Semiconductors**



PHILIPS