



Discontinued as of August 31, 2011



Panasonic

ideas for life

TV-5 rated.
1a 5A power relays

LK RELAYS



FEATURES

1. High inrush current capability

1) Operating load capability:
inrush 100 A, steady 5 A

2) UL, CSA, TV-5

2. High insulation resistance between contact and coil

1) Creepage distance and clearances between contact and coil: Min. 6 mm .236 inch (In compliance with IEC60065)

2) Surge withstand voltage between contact and coil: 10,000 V

3. Popular terminal pitch in AV equipment field

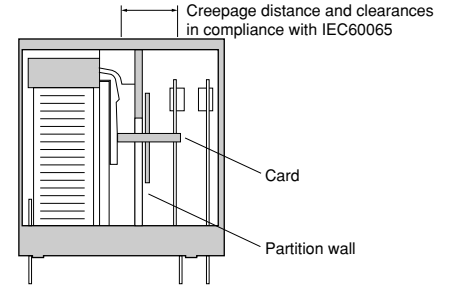

4. Space-saving slim type

Base area: Width 11 × Length 24 mm

Width .433 × Length .945 inch

5. Conforms to the various safety standards

UL, CSA, VDE, TÜV, SEMKO approved

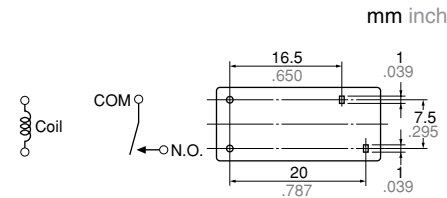

Compliance with RoHS Directive

TYPICAL APPLICATIONS

- AV equipment: TV's, VTR's, etc.
- OA equipment
- HA equipment

ORDERING INFORMATION

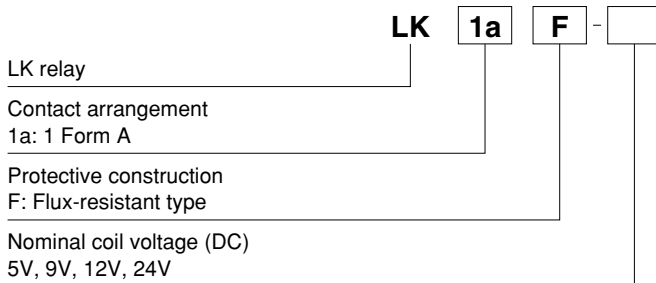

Notes: Certified by UL, CSA, TÜV and SEMKO
VDE approved type is available. Please consult us for details.

TYPES

Contact arrangement	Nominal coil voltage	Part No.
1 Form A	5V DC	LK1aF-5V
	9V DC	LK1aF-9V
	12V DC	LK1aF-12V
	24V DC	LK1aF-24V

Standard packing Carton: 100 pcs. Case: 500 pcs.



RATING

1. Coil data

Nominal coil voltage	Pick-up voltage (at 20°C 68°F)	Drop-out voltage (at 20°C 68°F)	Nominal operating current [±10%] (at 20°C 68°F)	Coil resistance [±10%] (at 20°C 68°F)	Nominal operating power	Max. applied voltage (at 20°C 68°F)
5V DC	70%V or less of nominal voltage (Initial)	10%V or more of nominal voltage (Initial)	106.4mA	47Ω	530mW	6.5V DC
9V DC			58.8mA	153Ω		11.7V DC
12V DC			44.2mA	272Ω		15.6V DC
24V DC			22.1mA	1,087Ω		31.2V DC

2. Specifications

Characteristics	Item	Specifications	
Contact	Arrangement	1 Form A	
	Contact resistance (Initial)	Max. 100 mΩ (By voltage drop 6V DC 1A)	
	Contact material	AgSnO ₂ type	
Rating	Nominal switching capacity	5A 277V AC (resistive load), 5A 30V DC (resistive load)	
	Max. switching power	1,385 VA, 150 W (resistive load)	
	Max. switching voltage	277V AC, 30V DC	
	Max. switching current	5A (AC), 5A (DC)	
	Min. switching capacity*1	100mA, 5V DC	
Electrical characteristics	Insulation resistance (Initial)	Min. 1,000MΩ (at 500V DC) Measurement at same location as "Breakdown voltage" section.	
	Breakdown voltage (Initial)	Between open contacts	1,000 Vrms for 1 min. (Detection current: 10 mA)
		Between contact and coil	4,000 Vrms for 1 min. (Detection current: 10 mA)
	Surge breakdown voltage*2 (Between contact and coil) (Initial)	10,000 V	
	Temperature rise (coil)	Max. 35°C 95°F (By resistive method, nominal coil voltage applied to the coil; contact carrying current: 5A, at 70°C 158°F)	
	Operate time (at nominal voltage) (at 20°C 68°F) (Initial)	Max. 15 ms (excluding contact bounce time.)	
Release time (at nominal voltage) (at 20°C 68°F) (Initial)	Max. 5 ms (excluding contact bounce time) (Without diode)		
Mechanical characteristics	Shock resistance	Functional	200 m/s ² (Half-wave pulse of sine wave: 11 ms; detection time: 10μs.)
		Destructive	1,000 m/s ² (Half-wave pulse of sine wave: 6 ms.)
	Vibration resistance	Functional	10 to 55 Hz at double amplitude of 1.5 mm (Detection time: 10μs.)
		Destructive	10 to 55 Hz at double amplitude of 1.5 mm
Expected life	Mechanical (at 180 times/min.)	Min. 2×10 ⁶	
	Electrical (at 20 times/min.)	Min. 10 ⁵ (at nominal switching capacity)	
Conditions	Conditions for operation, transport and storage*3	Ambient temperature: -40°C to +70°C -40°F to +158°F, Humidity: 5 to 85% R.H. (Not freezing and condensing at low temperature), Air pressure: 86 to 106kPa	
	Max. operating speed	20 times/min. (at nominal switching capacity)	
Unit weight		Approx. 12 g .42 oz	

Notes: *1. This value can change due to the switching frequency, environmental conditions, and desired reliability level, therefore it is recommended to check this with the actual load.

*2. Wave is standard shock voltage of ±1.2×50μs according to JEC-212-1981

*3. The upper limit of the ambient temperature is the maximum temperature that can satisfy the coil temperature rise value. Refer to Usage, transport and storage conditions in NOTES.

REFERENCE DATA

1. Max. switching power (AC resistive load)

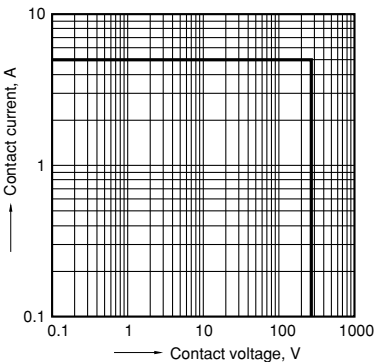

2. Coil temperature rise

Sample: LK1aF-12V, 6 pcs.
Point measured: coil inside
Contact current: 5 A

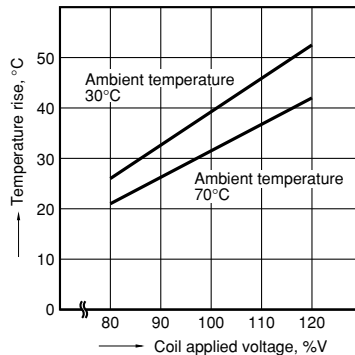

3. Ambient temperature characteristics

Contact current: 5 A

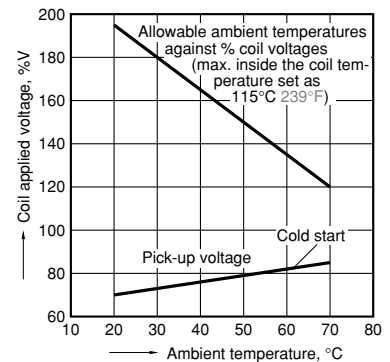



4. Life curve

Operation frequency: 20 times/min.
(ON/OFF = 1.5s: 1.5s)
Ambient temperature: room temperature

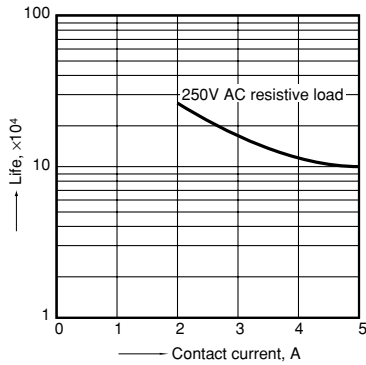

5-1. Operate & release time (without diode)

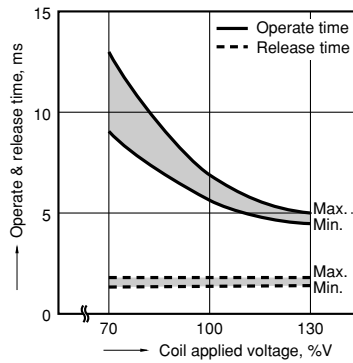

5-2. Operate & release time (with diode)

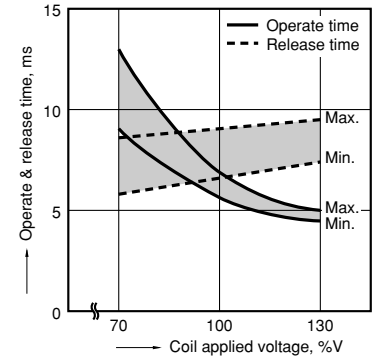

6-1. Electrical life test

(5 A 277 V AC, resistive load)

Sample: LK1aF-12V, 6 pcs.
Operation frequency: 20 times/min.
(ON/OFF = 1.5s: 1.5s)
Ambient temperature: 26°C 79°F

Circuit:

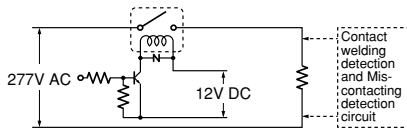

Change of pick-up and drop-out voltage

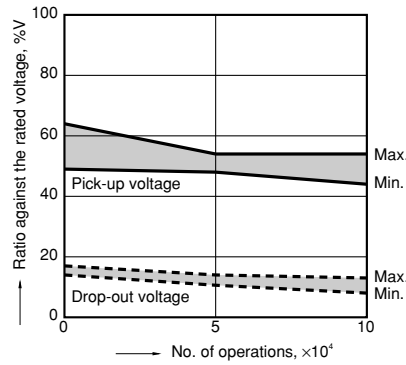

Change of contact resistance

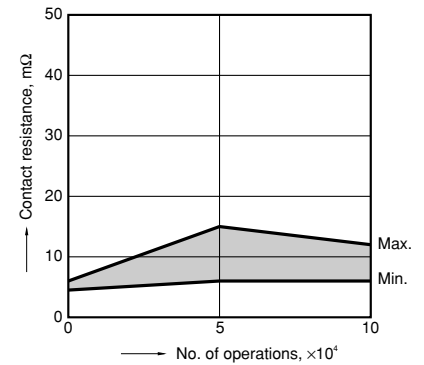

6-2. Electrical life test

(UL lamp load test TV-5)

Tested sample: LK1aF-12V, 6 pcs.

- Overload test
Load: 7.5 A 120 V AC (60 Hz),
Inrush: 111 A
Operation frequency: 10 times/min
(ON: OFF = 1 s: 5 s)
No. of operations: 50 ope.
- Endurance test
Load: 5A 120 V AC (60 Hz),
Inrush: 78 A
Operation frequency: 10 times/min
(ON: OFF = 1 s: 5 s)
No. of operations: 25,000 ope.

Change of pick-up and drop-out voltage

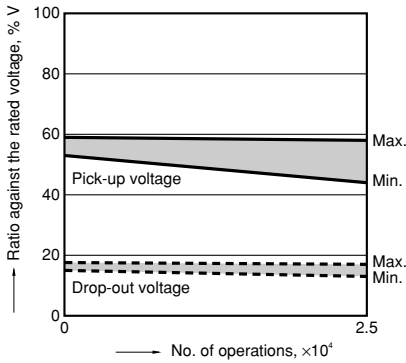

Change of contact resistance

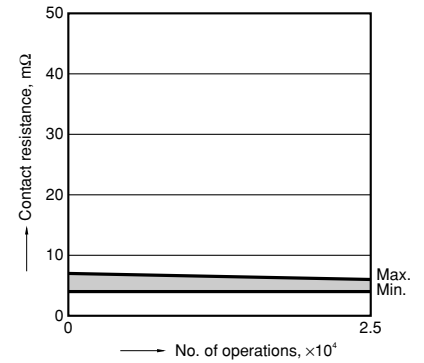



DIMENSIONS (mm inch)

The CAD data of the products with a **CAD Data** mark can be downloaded from: <http://panasonic-electric-works.net/ac>

CAD Data



External dimensions

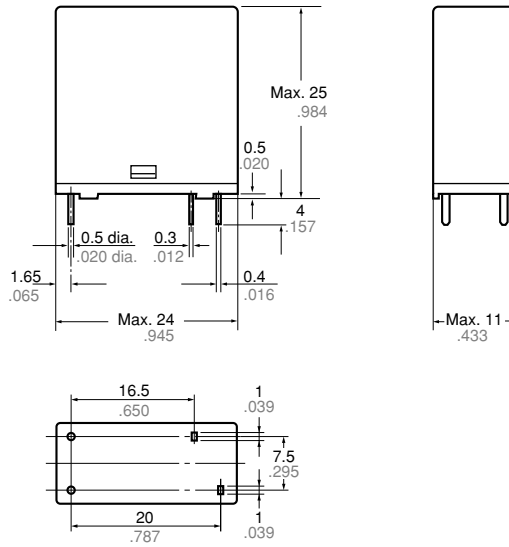

PC board pattern (Bottom view)

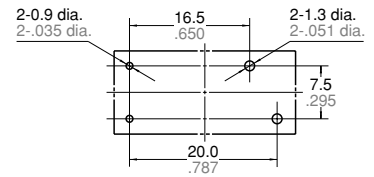

Tolerance: $\pm 0.1 \pm .004$

Schematic (Bottom view)



Dimension:
 Less than 1mm .039inch:
 Min. 1mm .039inch less than 3mm .118 inch:
 Min. 3mm .118 inch:

General tolerance
 $\pm 0.1 \pm .004$
 $\pm 0.2 \pm .008$
 $\pm 0.3 \pm .012$

SAFETY STANDARDS

UL/C-UL (Recognized)		CSA (Certified)		VDE (Certified)		TV rating (UL/CSA)		TÜV (Certified)		SEMKO (Certified)	
File No.	Contact rating	File No.	Contact rating	File No.	Contact rating	File No.	Rating	File No.	Rating	File No.	Contact rating
E43149	5A 277V AC 5A 30V DC	LR26550 etc.	5A 277V AC 5A 30V DC	40014390	5A 250V AC (cosφ=1.0)	UL E43149 CSA LR26550	TV-5	B 08 06 13461 245	5A 250V AC (cosφ=1.0) 5A 30V DC (0ms)	807779	3/100A 250V AC 5/40A 250V AC

For Cautions for Use.