

MC74HCT138A

1-of-8 Decoder/ Demultiplexer with LSTTL Compatible Inputs

High-Performance Silicon-Gate CMOS

The MC74HCT138A is identical in pinout to the LS138. The HCT138A may be used as a level converter for interfacing TTL or NMOS outputs to High Speed CMOS inputs.

The HCT138A decodes a three-bit Address to one-of-eight active-low outputs. This device features three Chip Select inputs, two active-low and one active-high to facilitate the demultiplexing, cascading, and chip-selecting functions. The demultiplexing function is accomplished by using the Address inputs to select the desired device output; one of the Chip Selects is used as a data input while the other Chip Selects are held in their active states.

Features

- Output Drive Capability: 10 LSTTL Loads
- TTL/NMOS Compatible Input Levels
- Outputs Directly Interface to CMOS, NMOS, and TTL
- Operating Voltage Range: 4.5 to 5.5 V
- Low Input Current: 1.0 μ A
- In Compliance with the Requirements Defined by JEDEC Standard No. 7A
- Chip Complexity: 122 FETs or 30.5 Equivalent Gates
- Pb-Free Packages are Available*



ON Semiconductor®

<http://onsemi.com>

MARKING DIAGRAMS

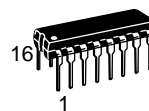

PDIP-16
N SUFFIX
CASE 648

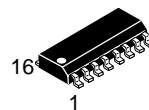
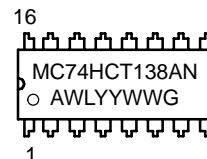

SOIC-16
D SUFFIX
CASE 751B

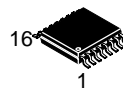
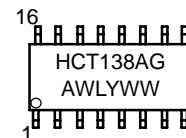

TSSOP-16
DT SUFFIX
CASE 948F

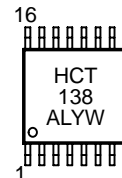

A = Assembly Location
WL, L = Wafer Lot
Y, YY = Year
W, WW = Work Week
G = Pb-Free Package

ORDERING INFORMATION

See detailed ordering and shipping information in the package dimensions section on page 2 of this data sheet.

*For additional information on our Pb-Free strategy and soldering details, please download the ON Semiconductor Soldering and Mounting Techniques Reference Manual, SOLDERRM/D.

MC74HCT138A

LOGIC DIAGRAM

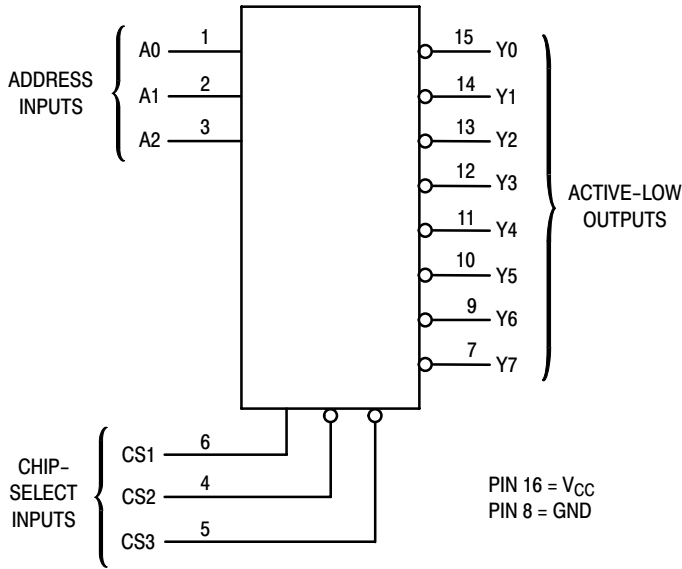

PIN ASSIGNMENT

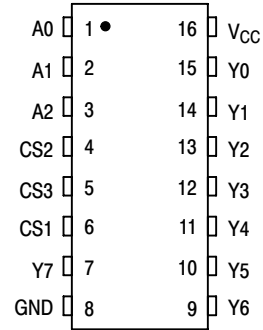

FUNCTION TABLE

Inputs			Outputs										
CS1	CS2	CS3	A2	A1	A0	Y0	Y1	Y2	Y3	Y4	Y5	Y6	Y7
X	X	H	X	X	X	H	H	H	H	H	H	H	H
X	H	X	X	X	X	H	H	H	H	H	H	H	H
L	X	X	X	X	X	H	H	H	H	H	H	H	H
H	L	L	L	L	L	L	H	H	H	H	H	H	H
H	L	L	L	L	H	H	L	H	H	H	H	H	H
H	L	L	L	H	L	H	H	H	L	H	H	H	H
H	L	L	H	L	L	H	H	H	H	L	H	H	H
H	L	L	H	H	L	H	H	H	H	H	L	L	H
H	L	L	H	H	H	H	H	H	H	H	H	H	L

H = high level (steady state)
L = low level (steady state)
X = don't care

Design Criteria	Value	Units
Internal Gate Count*	30.5	ea.
Internal Gate Propagation Delay	1.5	ns
Internal Gate Power Dissipation	5.0	μW
Speed Power Product	.0075	pJ

*Equivalent to a two-input NAND gate.

ORDERING INFORMATION

Device	Package	Shipping†
MC74HCT138AN	PDIP-16	500 Units / Box
MC74HCT138ANG	PDIP-16 (Pb-Free)	500 Units / Box
MC74HCT138AD	SOIC-16	48 Units / Rail
MC74HCT138ADG	SOIC-16 (Pb-Free)	48 Units / Rail
MC74HCT138ADR2	SOIC-16	2500 Units / Tape & Reel
MC74HCT138ADR2G	SOIC-16 (Pb-Free)	2500 Units / Tape & Reel
MC74HCT138ADTR2	TSSOP-16*	2500 Units / Tape & Reel

†For information on tape and reel specifications, including part orientation and tape sizes, please refer to our Tape and Reel Packaging Specifications Brochure, BRD8011/D.

*This package is inherently Pb-Free.

MC74HCT138A

MAXIMUM RATINGS

Symbol	Parameter	Value	Unit
V_{CC}	DC Supply Voltage (Referenced to GND)	- 0.5 to + 7.0	V
V_{in}	DC Input Voltage (Referenced to GND)	- 0.5 to $V_{CC} + 0.5$	V
V_{out}	DC Output Voltage (Referenced to GND)	- 0.5 to $V_{CC} + 0.5$	V
I_{in}	DC Input Current, per Pin	± 20	mA
I_{out}	DC Output Current, per Pin	± 25	mA
I_{CC}	DC Supply Current, V_{CC} and GND Pins	± 50	mA
P_D	Power Dissipation in Still Air	Plastic DIP†	750
		SOIC Package†	500
		TSSOP Package†	450
T_{stg}	Storage Temperature	- 65 to + 150	°C
T_L	Lead Temperature, 1 mm from Case for 10 Seconds (Plastic DIP, TSSOP or SOIC Package)	260	°C

This device contains protection circuitry to guard against damage due to high static voltages or electric fields. However, precautions must be taken to avoid applications of any voltage higher than maximum rated voltages to this high-impedance circuit. For proper operation, V_{in} and V_{out} should be constrained to the range $GND \leq (V_{in} \text{ or } V_{out}) \leq V_{CC}$. Unused inputs must always be tied to an appropriate logic voltage level (e.g., either GND or V_{CC}). Unused outputs must be left open.

Maximum ratings are those values beyond which device damage can occur. Maximum ratings applied to the device are individual stress limit values (not normal operating conditions) and are not valid simultaneously. If these limits are exceeded, device functional operation is not implied, damage may occur and reliability may be affected.

†Derating — Plastic DIP: - 10 mW/°C from 65° to 125°C

SOIC Package: - 7 mW/°C from 65° to 125°C

TSSOP Package: - 6.1 mW/°C from 65° to 125°C

For high frequency or heavy load considerations, see Chapter 2 of the ON Semiconductor High-Speed CMOS Data Book (DL129/D).

RECOMMENDED OPERATING CONDITIONS

Symbol	Parameter	Min	Max	Unit
V_{CC}	DC Supply Voltage (Referenced to GND)	4.5	5.5	V
V_{in}, V_{out}	DC Input Voltage, Output Voltage (Referenced to GND)	0	V_{CC}	V
T_A	Operating Temperature, All Package Types	- 55	+ 125	°C
t_r, t_f	Input Rise and Fall Time (Figure 1)	0	500	ns

DC ELECTRICAL CHARACTERISTICS (Voltages Referenced to GND)

Symbol	Parameter	Test Conditions	V_{CC} V	Guaranteed Limit			Unit
				- 55 to 25°C	≤ 85°C	≤ 125°C	
V_{IH}	Minimum High-Level Input Voltage	$V_{out} = 0.1 \text{ V or } V_{CC} - 0.1 \text{ V}$ $ I_{out} \leq 20 \mu\text{A}$	4.5	2.0	2.0	2.0	V
			5.5	2.0	2.0	2.0	
V_{IL}	Maximum Low-Level Input Voltage	$V_{out} = 0.1 \text{ V or } V_{CC} - 0.1 \text{ V}$ $ I_{out} \leq 20 \mu\text{A}$	4.5	0.8	0.8	0.8	V
			5.5	0.8	0.8	0.8	
V_{OH}	Minimum High-Level Output Voltage	$V_{in} = V_{IH} \text{ or } V_{IL}$ $ I_{out} \leq 20 \mu\text{A}$	4.5	4.4	4.4	4.4	V
			5.5	5.4	5.4	5.4	
V_{OL}	Maximum Low-Level Output Voltage	$V_{in} = V_{IH} \text{ or } V_{IL}$ $ I_{out} \leq 4.0 \mu\text{A}$	4.5	3.98	3.84	3.7	V
			5.5	0.1	0.1	0.1	
V_{OL}	Maximum Low-Level Output Voltage	$V_{in} = V_{IH} \text{ or } V_{IL}$ $ I_{out} \leq 20 \mu\text{A}$	4.5	0.1	0.1	0.1	V
			5.5	0.1	0.1	0.1	
V_{OL}	Maximum Low-Level Output Voltage	$V_{in} = V_{IH} \text{ or } V_{IL}$ $ I_{out} \leq 4.0 \text{ mA}$	4.5	0.26	0.33	0.4	V
			5.5	0.26	0.33	0.4	
I_{in}	Maximum Input Leakage Current	$V_{in} = V_{CC} \text{ or } GND$	6.0	± 0.1	± 1.0	± 1.0	μA
I_{CC}	Maximum Quiescent Supply Current (per Package)	$V_{in} = V_{CC} \text{ or } GND$ $I_{out} = 0 \mu\text{A}$	5.5	4.0	40	160	μA
ΔI_{CC}	Additional Quiescent Supply Current	$V_{in} = 2.4 \text{ V, Any One Input}$ $V_{in} = V_{CC} \text{ or } GND, \text{ Other Inputs}$ $I_{out} = 0 \mu\text{A}$	5.5	≥ - 55°C	25°C to 125°C		mA
				2.9	2.4		

NOTE: Information on typical parametric values can be found in Chapter 2 of the ON Semiconductor High-Speed CMOS Data Book (DL129/D).

MC74HCT138A

AC ELECTRICAL CHARACTERISTICS ($V_{CC} = 5.0\text{ V} \pm 10\%$, $C_L = 50\text{ pF}$, Input $t_r = t_f = 6.0\text{ ns}$)

Symbol	Parameter	Guaranteed Limit			Unit
		- 55 to 25°C	≤ 85°C	≤ 125°C	
t_{PLH} , t_{PHL}	Maximum Propagation Delay, Input A to Output Y (Figures 1 and 4)	30	38	45	ns
t_{PLH} , t_{PHL}	Maximum Propagation Delay, CS1 to Output Y (Figures 2 and 4)	27	34	41	ns
t_{PLH} , t_{PHL}	Maximum Output Transition Time, CS2 or CS3 to Output Y (Figures 3 and 4)	30	38	45	ns
t_{TLH} , t_{THL}	Maximum Output Transition Time, Any Output (Figures 2 and 4)	15	19	22	ns
t_r , t_f	Maximum Input Rise and Fall Time	500	500	500	ns
C_{in}	Maximum Input Capacitance	10	10	10	pF

NOTE: For propagation delays with loads other than 50 pF, and information on typical parametric values, see Chapter 2 of the ON Semiconductor High-Speed CMOS Data Book (DL129/D).

C_{PD}	Power Dissipation Capacitance (Per Enabled Output)*	Typical @ 25°C, $V_{CC} = 5.0\text{ V}$	pF
		51	

* Used to determine the no-load dynamic power consumption: $P_D = C_{PD} V_{CC}^2 f + I_{CC} V_{CC}$. For load considerations, see Chapter 2 of the ON Semiconductor High-Speed CMOS Data Book (DL129/D).

EXPANDED LOGIC DIAGRAM

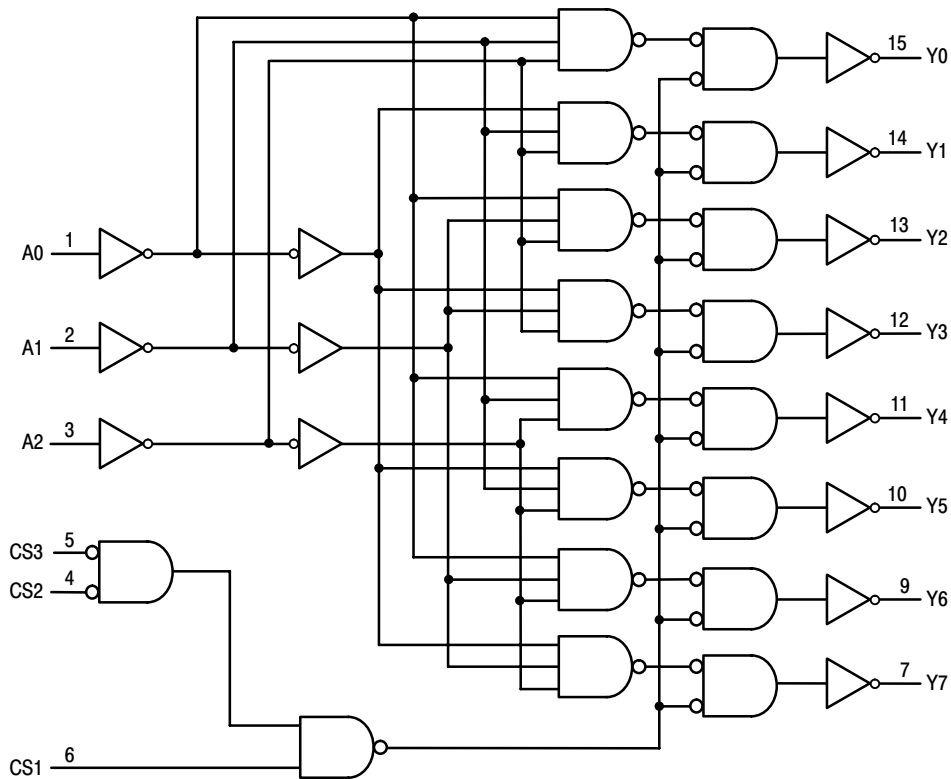

MC74HCT138A

SWITCHING WAVEFORMS

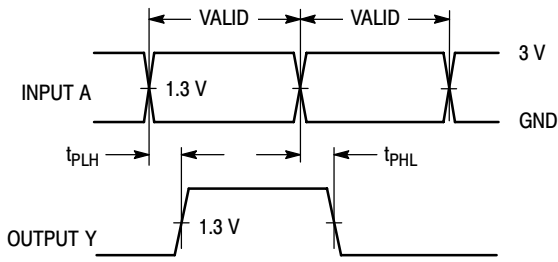

Figure 1.

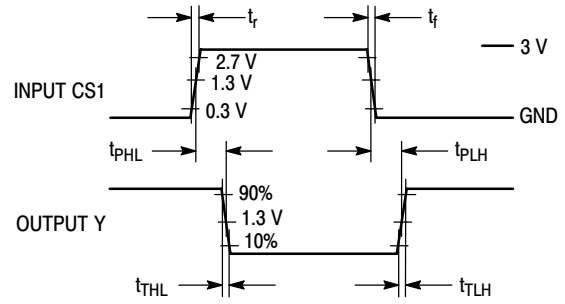

Figure 2.

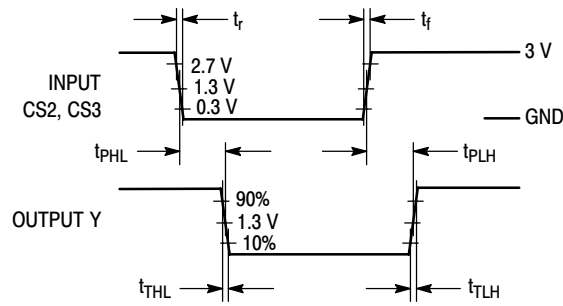
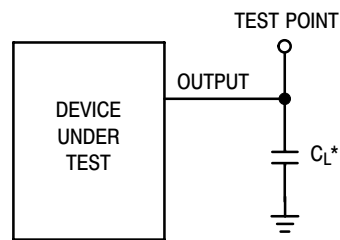

Figure 3.

TEST CIRCUIT



*Includes all probe and jig capacitance

Figure 4.

MC74HCT138A

PACKAGE DIMENSIONS

PDIP-16
N SUFFIX
CASE 648-08
ISSUE T

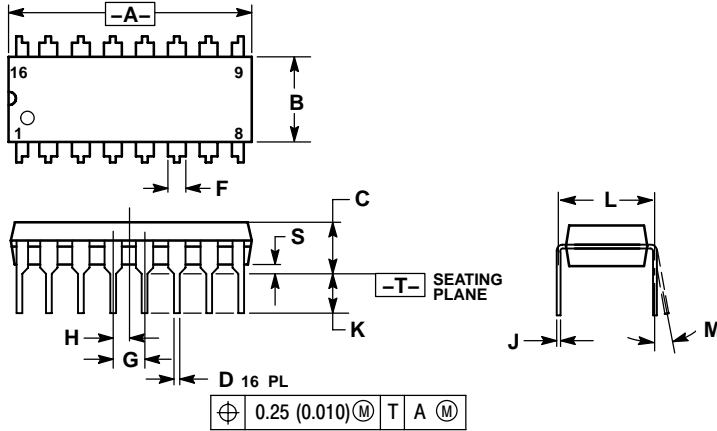

- NOTES:
1. DIMENSIONING AND TOLERANCING PER ANSI Y14.5M, 1982.
 2. CONTROLLING DIMENSION: INCH.
 3. DIMENSION L TO CENTER OF LEADS WHEN FORMED PARALLEL.
 4. DIMENSION B DOES NOT INCLUDE MOLD FLASH.
 5. ROUNDED CORNERS OPTIONAL.

DIM	INCHES		MILLIMETERS	
	MIN	MAX	MIN	MAX
A	0.740	0.770	18.80	19.55
B	0.250	0.270	6.35	6.85
C	0.145	0.175	3.69	4.44
D	0.015	0.021	0.39	0.53
F	0.040	0.70	1.02	1.77
G	0.100 BSC		2.54 BSC	
H	0.050 BSC		1.27 BSC	
J	0.008	0.015	0.21	0.38
K	0.110	0.130	2.80	3.30
L	0.295	0.305	7.50	7.74
M	0°		10°	
S	0.020	0.040	0.51	1.01

SOIC-16
D SUFFIX
CASE 751B-05
ISSUE J

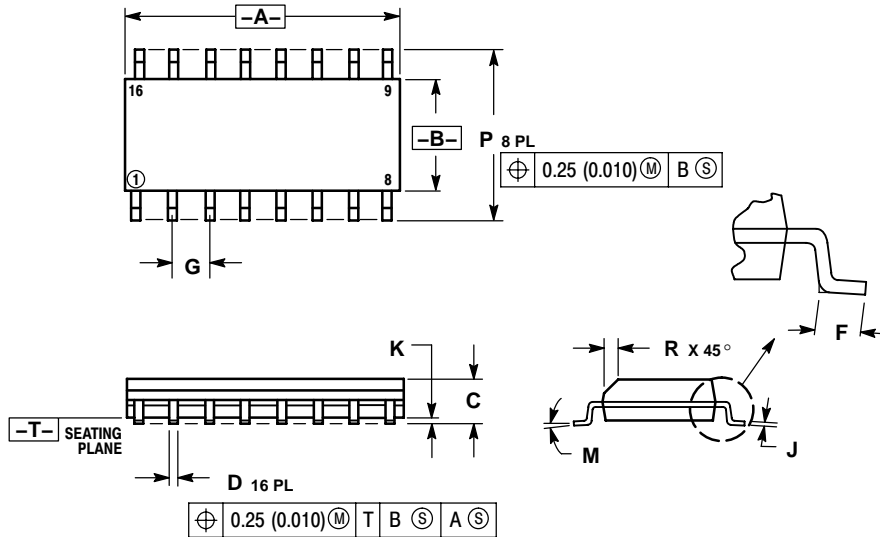

- NOTES:
1. DIMENSIONING AND TOLERANCING PER ANSI Y14.5M, 1982.
 2. CONTROLLING DIMENSION: MILLIMETER.
 3. DIMENSIONS A AND B DO NOT INCLUDE MOLD PROTRUSION.
 4. MAXIMUM MOLD PROTRUSION 0.15 (0.006) PER SIDE.
 5. DIMENSION D DOES NOT INCLUDE DAMBAR PROTRUSION. ALLOWABLE DAMBAR PROTRUSION SHALL BE 0.127 (0.005) TOTAL IN EXCESS OF THE D DIMENSION AT MAXIMUM MATERIAL CONDITION.

DIM	MILLIMETERS		INCHES	
	MIN	MAX	MIN	MAX
A	9.80	10.00	0.386	0.393
B	3.80	4.00	0.150	0.157
C	1.35	1.75	0.054	0.068
D	0.35	0.49	0.014	0.019
F	0.40	1.25	0.016	0.049
G	1.27 BSC		0.050 BSC	
J	0.19	0.25	0.008	0.009
K	0.10	0.25	0.004	0.009
M	0°		7°	
P	5.80	6.20	0.229	0.244
R	0.25	0.50	0.010	0.019

MC74HCT138A

PACKAGE DIMENSIONS

TSSOP-16
DT SUFFIX
CASE 948F-01
ISSUE A

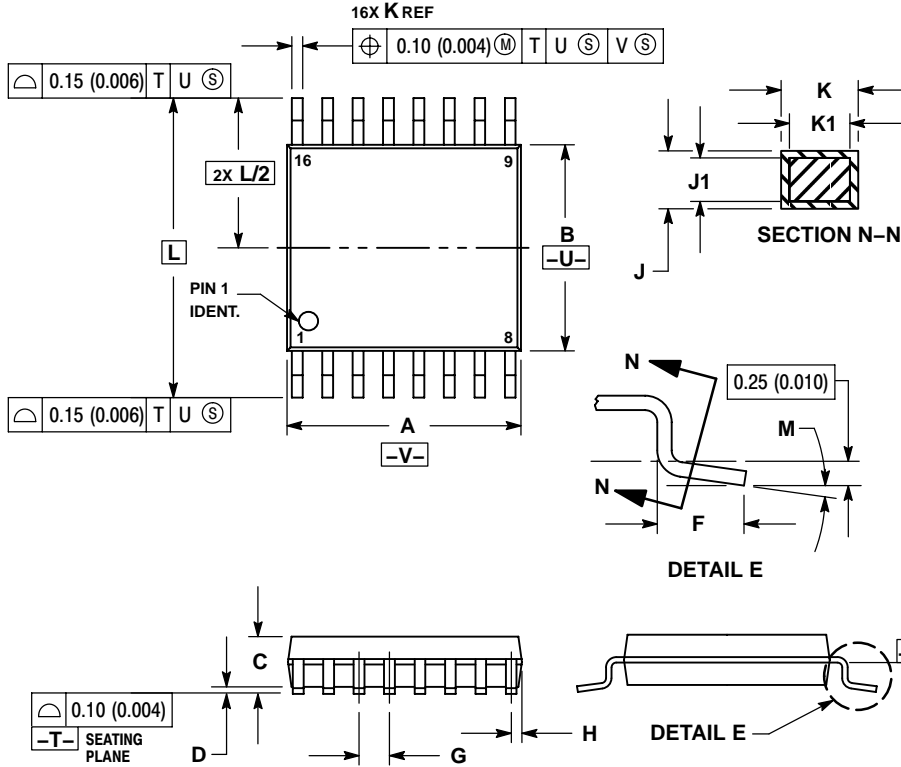

NOTES:

1. DIMENSIONING AND TOLERANCING PER ANSI Y14.5M, 1982.
2. CONTROLLING DIMENSION: MILLIMETER.
3. DIMENSION A DOES NOT INCLUDE MOLD FLASH, PROTRUSIONS OR GATE BURRS. MOLD FLASH OR GATE BURRS SHALL NOT EXCEED 0.15 (0.006) PER SIDE.
4. DIMENSION B DOES NOT INCLUDE INTERLEAD FLASH OR PROTRUSION. INTERLEAD FLASH OR PROTRUSION SHALL NOT EXCEED 0.25 (0.010) PER SIDE.
5. DIMENSION K DOES NOT INCLUDE DAMBAR PROTRUSION. ALLOWABLE DAMBAR PROTRUSION SHALL BE 0.08 (0.003) TOTAL IN EXCESS OF THE K DIMENSION AT MAXIMUM MATERIAL CONDITION.
6. TERMINAL NUMBERS ARE SHOWN FOR REFERENCE ONLY.
7. DIMENSION A AND B ARE TO BE DETERMINED AT DATUM PLANE -W-.

DIM	MILLIMETERS		INCHES	
	MIN	MAX	MIN	MAX
A	4.90	5.10	0.193	0.200
B	4.30	4.50	0.169	0.177
C	---	1.20	---	0.047
D	0.05	0.15	0.002	0.006
F	0.50	0.75	0.020	0.030
G	0.65 BSC		0.026 BSC	
H	0.18	0.28	0.007	0.011
J	0.09	0.20	0.004	0.008
J1	0.09	0.16	0.004	0.006
K	0.19	0.30	0.007	0.012
K1	0.19	0.25	0.007	0.010
L	6.40 BSC		0.252 BSC	
M	0°	8°	0°	8°

MC74HCT138A

ON Semiconductor and **ON** are registered trademarks of Semiconductor Components Industries, LLC (SCILLC). SCILLC reserves the right to make changes without further notice to any products herein. SCILLC makes no warranty, representation or guarantee regarding the suitability of its products for any particular purpose, nor does SCILLC assume any liability arising out of the application or use of any product or circuit, and specifically disclaims any and all liability, including without limitation special, consequential or incidental damages. "Typical" parameters which may be provided in SCILLC data sheets and/or specifications can and do vary in different applications and actual performance may vary over time. All operating parameters, including "Typicals" must be validated for each customer application by customer's technical experts. SCILLC does not convey any license under its patent rights nor the rights of others. SCILLC products are not designed, intended, or authorized for use as components in systems intended for surgical implant into the body, or other applications intended to support or sustain life, or for any other application in which the failure of the SCILLC product could create a situation where personal injury or death may occur. Should Buyer purchase or use SCILLC products for any such unintended or unauthorized application, Buyer shall indemnify and hold SCILLC and its officers, employees, subsidiaries, affiliates, and distributors harmless against all claims, costs, damages, and expenses, and reasonable attorney fees arising out of, directly or indirectly, any claim of personal injury or death associated with such unintended or unauthorized use, even if such claim alleges that SCILLC was negligent regarding the design or manufacture of the part. SCILLC is an Equal Opportunity/Affirmative Action Employer. This literature is subject to all applicable copyright laws and is not for resale in any manner.

PUBLICATION ORDERING INFORMATION

LITERATURE FULFILLMENT:

Literature Distribution Center for ON Semiconductor
P.O. Box 61312, Phoenix, Arizona 85082-1312 USA
Phone: 480-829-7710 or 800-344-3860 Toll Free USA/Canada
Fax: 480-829-7709 or 800-344-3867 Toll Free USA/Canada
Email: orderlit@onsemi.com

N. American Technical Support: 800-282-9855 Toll Free
USA/Canada

Japan: ON Semiconductor, Japan Customer Focus Center
2-9-1 Kamimeguro, Meguro-ku, Tokyo, Japan 153-0051
Phone: 81-3-5773-3850

ON Semiconductor Website: <http://onsemi.com>

Order Literature: <http://www.onsemi.com/litorder>

For additional information, please contact your
local Sales Representative.

MC74HCT138A/D