



M4N37

**6-Pin DIP Optoisolators
Transistor Output**

The M4N37 device consists of a gallium arsenide infrared emitting diode optically coupled to a monolithic silicon phototransistor detector.

- Current Transfer Ratio — 100% Minimum @ Specified Conditions
- Guaranteed Switching Speeds
- Meets or Exceeds All JEDEC Registered Specifications

Applications

- General Purpose Switching Circuits
- Interfacing and coupling systems of different potentials and impedances
- Regulation Feedback Circuits
- Monitor & Detection Circuits
- Solid State Relays

MAXIMUM RATINGS ($T_A = 25^\circ\text{C}$ unless otherwise noted)

Rating	Symbol	Value	Unit
--------	--------	-------	------

INPUT LED

Reverse Voltage	V_R	6	Volts
Forward Current — Continuous	I_F	60	mA
LED Power Dissipation @ $T_A = 25^\circ\text{C}$ with Negligible Power in Output Detector Derate above 25°C	P_D	100 1.41	mW mW/ $^\circ\text{C}$

OUTPUT TRANSISTOR

Collector–Emitter Voltage	V_{CEO}	30	Volts
Emitter–Base Voltage	V_{EBO}	7	Volts
Collector–Base Voltage	V_{CB0}	70	Volts
Collector Current — Continuous	I_C	50	mA
Detector Power Dissipation @ $T_A = 25^\circ\text{C}$ with Negligible Power in Input LED Derate above 25°C	P_D	150 1.76	mW mW/ $^\circ\text{C}$

TOTAL DEVICE

Isolation Source Voltage ⁽¹⁾ (Peak ac Voltage, 60 Hz, 1 sec Duration)	V_{ISO}	7500	Vac(pk)
Total Device Power Dissipation @ $T_A = 25^\circ\text{C}$ Derate above 25°C	P_D	250 2.94	mW mW/ $^\circ\text{C}$
Ambient Operating Temperature Range ⁽²⁾	T_A	-55 to +100	$^\circ\text{C}$
Storage Temperature Range ⁽²⁾	T_{stg}	-55 to +150	$^\circ\text{C}$
Soldering Temperature (10 sec, 1/16" from case)	T_L	260	$^\circ\text{C}$

1. Isolation surge voltage is an internal device dielectric breakdown rating.
For this test, Pins 1 and 2 are common, and Pins 4, 5 and 6 are common.
2. Refer to Quality and Reliability Section in Opto Data Book for information on test conditions.

STYLE 1 PLASTIC

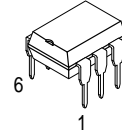

STANDARD THRU HOLE

SCHEMATIC

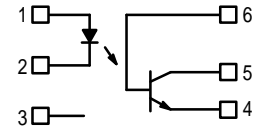

- PIN 1. LED ANODE
2. LED CATHODE
3. N.C.
4. EMITTER
5. COLLECTOR
6. BASE

M4N37

ELECTRICAL CHARACTERISTICS ($T_A = 25^\circ\text{C}$ unless otherwise noted)⁽¹⁾

Characteristic	Symbol	Min	Typ ⁽¹⁾	Max	Unit	
INPUT LED						
Forward Voltage ($I_F = 10\text{ mA}$)	V_F	$T_A = 25^\circ\text{C}$	0.8	1.15	1.5	Volts
		$T_A = -55^\circ\text{C}$	0.9	1.3	1.7	
		$T_A = 100^\circ\text{C}$	0.7	1.05	1.4	
Reverse Leakage Current ($V_R = 6\text{ V}$)	I_R	—	—	10	μA	
Capacitance ($V = 0\text{ V}$, $f = 1\text{ MHz}$)	C_J	—	18	—	pF	

OUTPUT TRANSISTOR

Collector–Emitter Dark Current ($V_{CE} = 10\text{ V}$, $T_A = 25^\circ\text{C}$)	I_{CEO}	—	1	50	nA
($V_{CE} = 30\text{ V}$, $T_A = 100^\circ\text{C}$)		—	—	500	μA
Collector–Base Dark Current ($V_{CB} = 10\text{ V}$)	I_{CBO}	—	0.2 100	20 —	nA
$T_A = 25^\circ\text{C}$					
$T_A = 100^\circ\text{C}$					
Collector–Emitter Breakdown Voltage ($I_C = 1\text{ mA}$)	$V_{(BR)CEO}$	30	45	—	Volts
Collector–Base Breakdown Voltage ($I_C = 100\text{ }\mu\text{A}$)	$V_{(BR)CBO}$	70	100	—	Volts
Emitter–Base Breakdown Voltage ($I_E = 100\text{ }\mu\text{A}$)	$V_{(BR)EBO}$	7	7.8	—	Volts
DC Current Gain ($I_C = 2\text{ mA}$, $V_{CE} = 5\text{ V}$)	h_{FE}	—	400	—	—
Collector–Emitter Capacitance ($f = 1\text{ MHz}$, $V_{CE} = 0$)	C_{CE}	—	7	—	pF
Collector–Base Capacitance ($f = 1\text{ MHz}$, $V_{CB} = 0$)	C_{CB}	—	19	—	pF
Emitter–Base Capacitance ($f = 1\text{ MHz}$, $V_{EB} = 0$)	C_{EB}	—	9	—	pF

COUPLED

Output Collector Current ($I_F = 10\text{ mA}$, $V_{CE} = 10\text{ V}$)	$T_A = 25^\circ\text{C}$ $T_A = -55^\circ\text{C}$ $T_A = 100^\circ\text{C}$	I_C (CTR) ⁽²⁾	10 (100) 4 (40) 4 (40)	30 (300) — —	— — —	mA (%)
Collector–Emitter Saturation Voltage ($I_C = 0.5\text{ mA}$, $I_F = 10\text{ mA}$)		$V_{CE(sat)}$	—	0.14	0.3	Volts
Turn–On Time	$(I_C = 2\text{ mA}$, $V_{CC} = 10\text{ V}$, $R_L = 100\text{ }\Omega$) ⁽³⁾	t_{on}	—	7.5	10	μs
Turn–Off Time		t_{off}	—	5.7	10	
Rise Time		t_r	—	3.2	—	
Fall Time		t_f	—	4.7	—	
Isolation Voltage ($f = 60\text{ Hz}$, $t = 1\text{ sec}$)		V_{ISO}	7500	—	—	Vac(pk)
Isolation Current ⁽⁴⁾ ($V_{I-O} = 1500\text{ Vpk}$)		I_{ISO}	—	8	100	μA
Isolation Resistance ($V = 500\text{ V}$) ⁽⁴⁾		R_{ISO}	10^{11}	—	—	Ω
Isolation Capacitance ($V = 0\text{ V}$, $f = 1\text{ MHz}$) ⁽⁴⁾		C_{ISO}	—	0.2	2	pF

1. Always design to the specified minimum/maximum electrical limits (where applicable).

2. Current Transfer Ratio (CTR) = $I_C/I_F \times 100\%$.

3. For test circuit setup and waveforms, refer to Figure 14.

4. For this test, Pins 1 and 2 are common, and Pins 4, 5 and 6 are common.

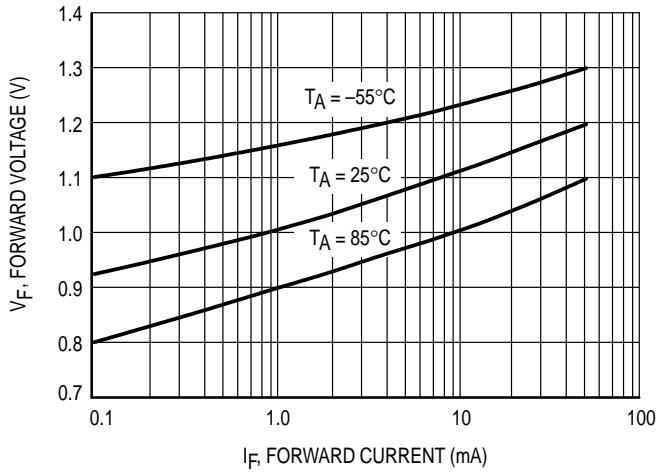

Figure 1. Forward Voltage vs. Forward Current

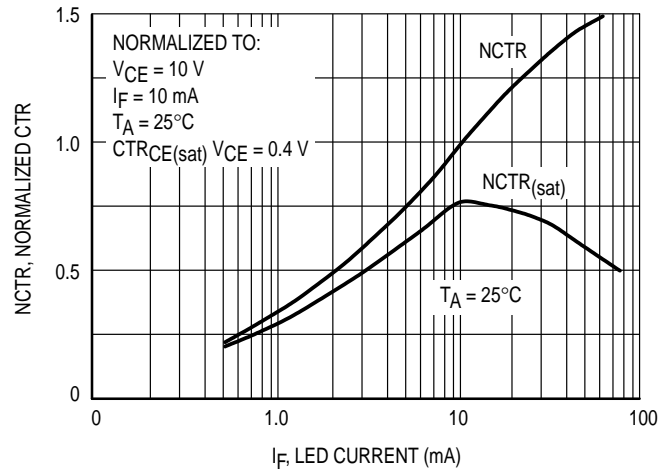

Figure 2. Normalized Non-Saturated and Saturated CTR, $T_A = 25^\circ\text{C}$ vs. LED Current

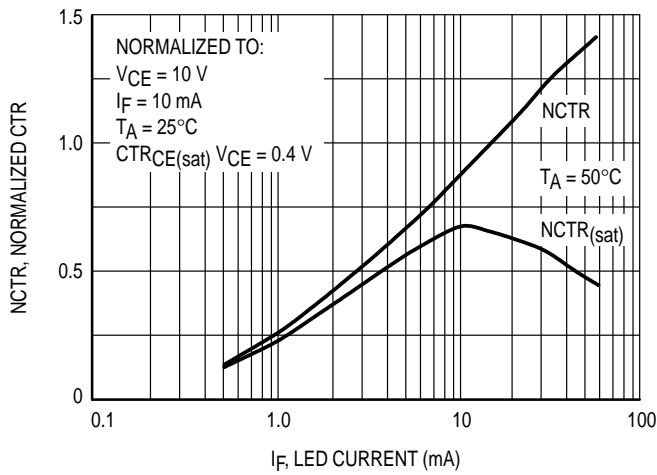

Figure 3. Normalized Non-Saturated and Saturated CTR, $T_A = 50^\circ\text{C}$ vs. LED Current

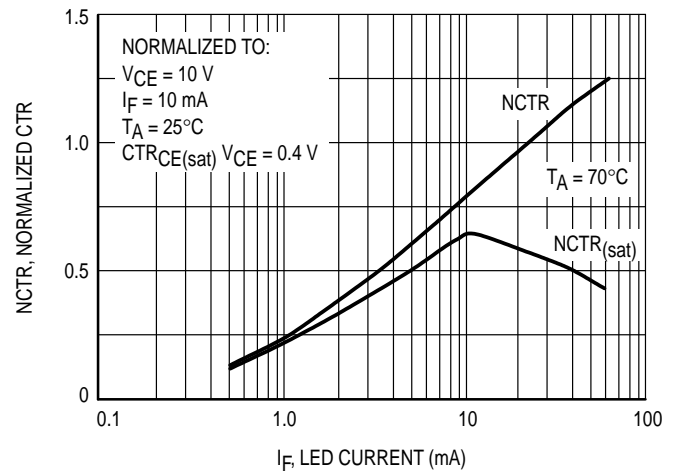

Figure 4. Normalized Non-Saturated and Saturated CTR, $T_A = 70^\circ\text{C}$ vs. LED Current

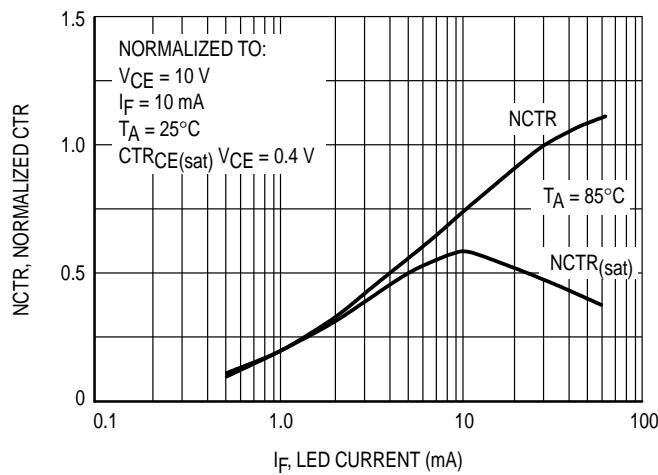

Figure 5. Normalized Non-Saturated and Saturated CTR, $T_A = 85^\circ\text{C}$ vs. LED Current

M4N37

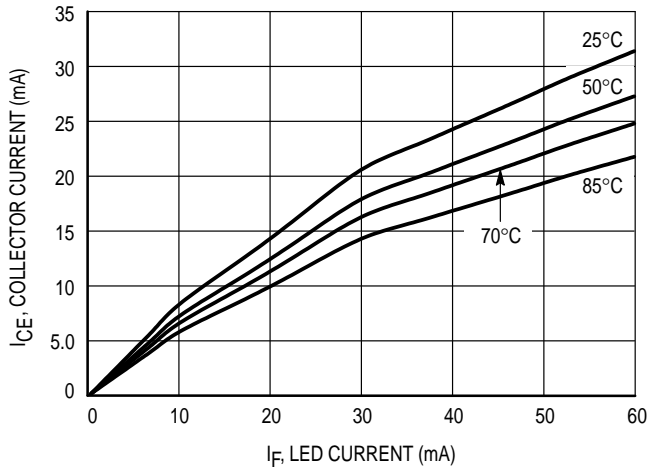

Figure 6. Collector–Emitter Current vs. Temperature and LED Current

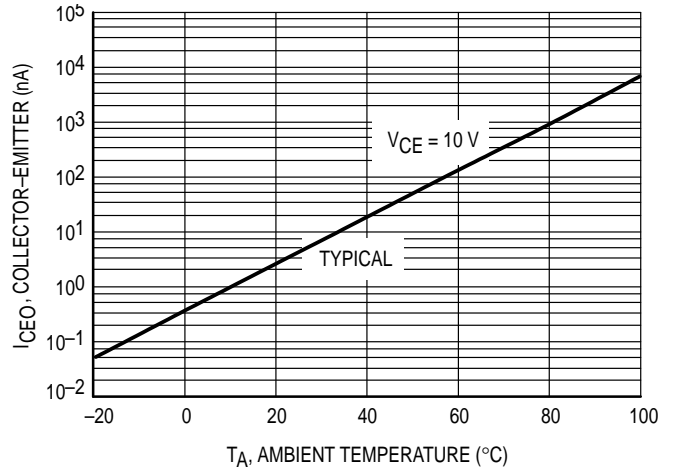

Figure 7. Collector–Emitter Leakage Current vs. Temperature

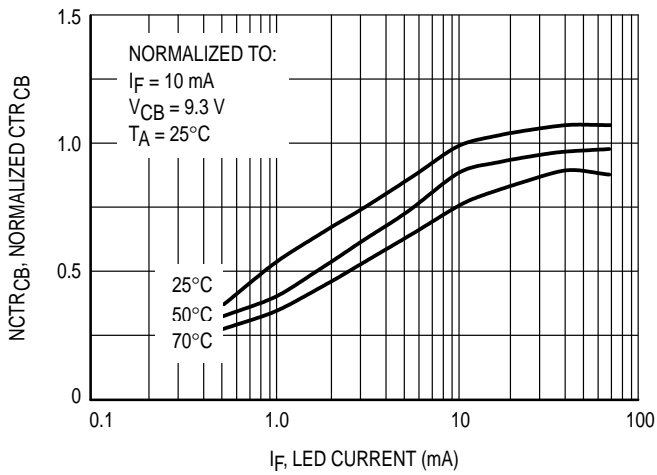

Figure 8. Normalized CTR_{cb} vs. LED Current and Temperature

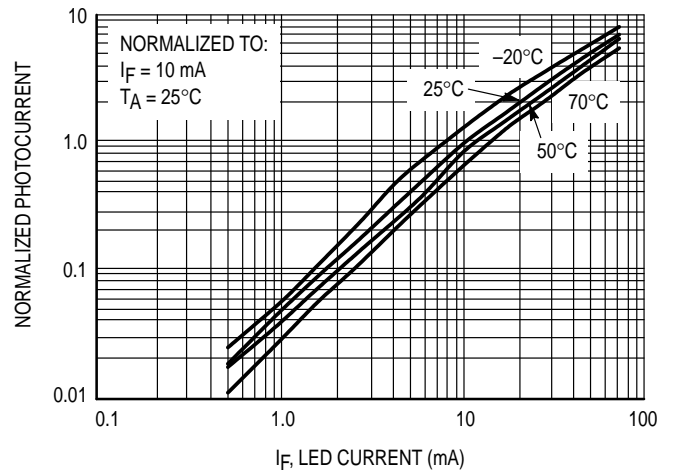

Figure 9. Normalized Photocurrent vs. I_F and Temperature

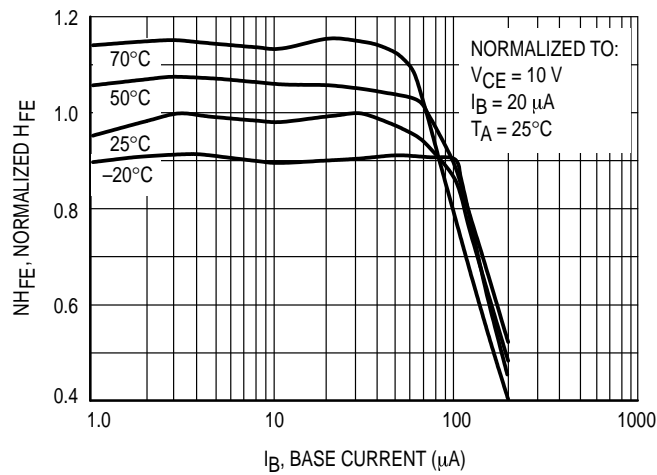

Figure 10. Normalized Non–Saturated H_{FE} vs. Base Current and Temperature

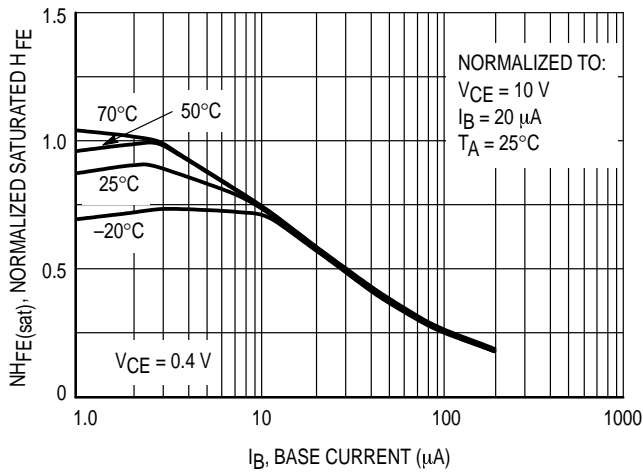

Figure 11. Normalized H_{FE} vs. Base Current and Temperature

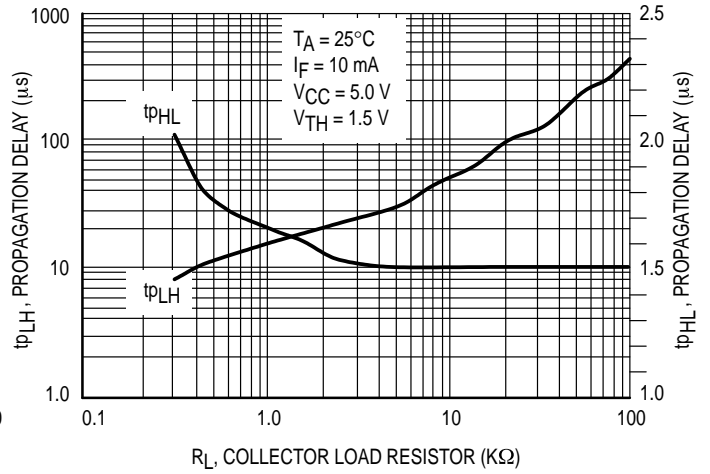

Figure 12. Propagation Delay vs. Collector Load Resistor

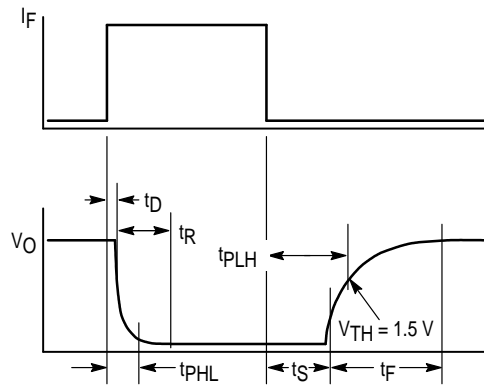

Figure 13. Switching Timing

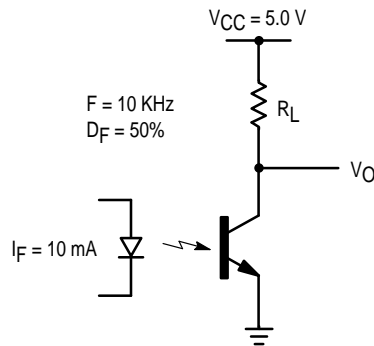
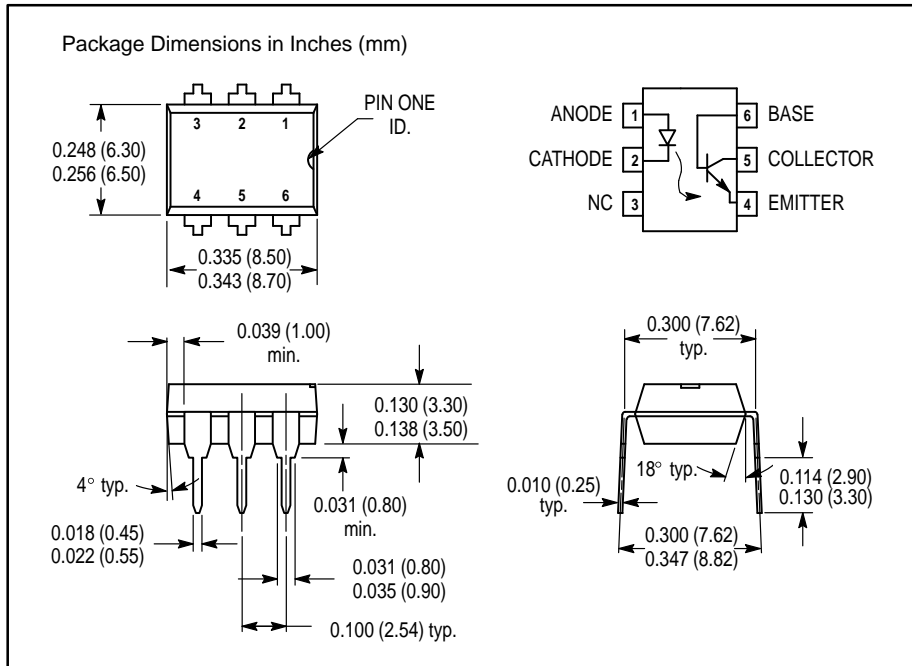



Figure 14. Switching Schematic

M4N37



Motorola reserves the right to make changes without further notice to any products herein. Motorola makes no warranty, representation or guarantee regarding the suitability of its products for any particular purpose, nor does Motorola assume any liability arising out of the application or use of any product or circuit, and specifically disclaims any and all liability, including without limitation consequential or incidental damages. "Typical" parameters which may be provided in Motorola data sheets and/or specifications can and do vary in different applications and actual performance may vary over time. All operating parameters, including "Typicals" must be validated for each customer application by customer's technical experts. Motorola does not convey any license under its patent rights nor the rights of others. Motorola products are not designed, intended, or authorized for use as components in systems intended for surgical implant into the body, or other applications intended to support or sustain life, or for any other application in which the failure of the Motorola product could create a situation where personal injury or death may occur. Should Buyer purchase or use Motorola products for any such unintended or unauthorized application, Buyer shall indemnify and hold Motorola and its officers, employees, subsidiaries, affiliates, and distributors harmless against all claims, costs, damages, and expenses, and reasonable attorney fees arising out of, directly or indirectly, any claim of personal injury or death associated with such unintended or unauthorized use, even if such claim alleges that Motorola was negligent regarding the design or manufacture of the part. Motorola and  are registered trademarks of Motorola, Inc. Motorola, Inc. is an Equal Opportunity/Affirmative Action Employer.

Mfax is a trademark of Motorola, Inc.

How to reach us:

USA/EUROPE/Locations Not Listed: Motorola Literature Distribution;
P.O. Box 5405, Denver, Colorado 80217. 303-675-2140 or 1-800-441-2447

JAPAN: Nippon Motorola Ltd.; Tatsumi-SPD-JLDC, 6F Seibu-Butsuryu-Center,
3-14-2 Tatsumi Koto-Ku, Tokyo 135, Japan. 81-3-3521-8315

Mfax™: RMFAX0@email.sps.mot.com – TOUCHTONE 602-244-6609
– US & Canada ONLY 1-800-774-1848

ASIA/PACIFIC: Motorola Semiconductors H.K. Ltd.; 8B Tai Ping Industrial Park,
51 Ting Kok Road, Tai Po, N.T., Hong Kong. 852-26629298

INTERNET: <http://www.mot.com/SPS/>



MOTOROLA

