

IRFF130, IRFF131, IRFF132, IRFF133
Power MOS Field-Effect Transistors

File Number 1564

**N-Channel Enhancement-Mode
Power Field-Effect Transistors**

7.0A and 8.0A, 60V-100V
 $r_{DS(on)} = 0.18 \Omega$ and 0.25Ω

Features:

- SOA is power-dissipation limited
- Nanosecond switching speeds
- Linear transfer characteristics
- High input impedance
- Majority carrier device

The IRFF130, IRFF131, IRFF132 and IRFF133 are n-channel enhancement-mode silicon-gate power field-effect transistors designed for applications such as switching regulators, switching converters, motor drivers, relay drivers, and drivers for high-power bipolar switching transistors requiring high speed and low gate-drive power. These types can be operated directly from integrated circuits.

The IRFF-types are supplied in the JEDEC TO-205AF (LOW-PROFILE TO-39) metal package.

N-CHANNEL ENHANCEMENT MODE

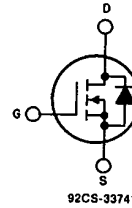

TERMINAL DIAGRAM

TERMINAL DESIGNATION

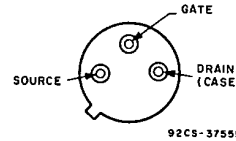

JEDEC TO-205AF

Absolute Maximum Ratings

Parameter	IRFF130	IRFF131	IRFF132	IRFF133	Units
V_{DS} Drain - Source Voltage (1)	100	60	100	60	V
V_{DGR} Drain - Gate Voltage ($I_{GS} = 20 \text{ k}\Omega$) (1)	100	60	100	60	V
$I_D @ T_C = 25^\circ\text{C}$ Continuous Drain Current	8.0	8.0	7.0	7.0	A
I_{DM} Pulsed Drain Current (2)	32	32	28	28	A
V_{GS} Gate - Source Voltage	± 20				V
$P_D @ T_C = 25^\circ\text{C}$ Max. Power Dissipation	25 (See Fig 14)				W
Linear Derating Factor	0.2 (See Fig 14)				W/ $^\circ\text{C}$
I_{LM} Inductive Current, Clamped	(See Fig 15 and 16) $L = 100 \mu\text{H}$				A
T_J Operating Junction and Storage Temperature Range	-55 to 150				$^\circ\text{C}$
T_{stg} Lead Temperature	300 (0.063 in. (1.6mm) from case for 10s)				$^\circ\text{C}$

IRFF130, IRFF131, IRFF132, IRFF133

Electrical Characteristics @ T_C = 25°C (Unless Otherwise Specified)

Parameter	Type	Min.	Typ	Max.	Units	Test Conditions
BV _{DSS} Drain - Source Breakdown Voltage	IRFF130 IRFF132	100	-	-	V	V _{GS} = 0V
	IRFF131 IRFF133	60	-	-	V	I _D = 250μA
V _{GS(th)} Gate Threshold Voltage	ALL	2.0	-	4.0	V	V _{DS} = V _{GS} , I _D = 250μA
I _{GSS} Gate-Source Leakage Forward	ALL	-	-	100	nA	V _{GS} = 20V
I _{GSS} Gate-Source Leakage Reverse	ALL	-	-	-100	nA	V _{GS} = -20V
I _{DSS} Zero Gate Voltage Drain Current	ALL	-	-	250	μA	V _{DS} = Max. Rating, V _{GS} = 0V
		-	-	1000	μA	V _{DS} = Max. Rating x 0.8, V _{GS} = 0V, T _C = 125°C
I _{D(on)} On-State Drain Current ②	IRFF130 IRFF131	8.0	-	-	A	V _{DS} > I _{D(on)} x R _{DS(on)} max., V _{GS} = 10V
	IRFF132 IRFF133	7.0	-	-	A	
R _{DS(on)} Static Drain-Source On State Resistance ②	IRFF130 IRFF131	-	0.14	0.18	Ω	V _{GS} = 10V, I _D = 4.0A
	IRFF132 IRFF133	-	0.20	0.25	Ω	
g _{fs} Forward Transconductance ②	ALL	4.0	5.5	-	S (Ω)	V _{DS} > I _{D(on)} x R _{DS(on)} max., I _D = 4.0A
C _{iss} Input Capacitance	ALL	-	600	800	pF	V _{GS} = 0V, V _{DS} = 25V, f = 1.0 MHz
C _{oss} Output Capacitance	ALL	-	300	500	pF	See Fig 10
C _{rss} Reverse Transfer Capacitance	ALL	-	100	150	pF	
t _{d(on)} Turn On Delay Time	ALL	-	30	50	ns	V _{DD} = 0.5 BV _{DSS} , I _D = 4.0A, Z _o = 50Ω
t _r Rise Time	ALL	-	80	150	ns	See Fig 17
t _{d(off)} Turn Off Delay Time	ALL	-	50	100	ns	(MOSFET switching times are essentially independent of operating temperature.)
t _f Fall Time	ALL	-	80	150	ns	
Q _g Total Gate Charge (Gate-Source Plus Gate-Drain)	ALL	-	18	30	nC	V _{GS} = 10V, I _D = 18A, V _{DS} = 0.8 Max. Rating. See Fig 18 for test circuit. (Gate charge is essentially independent of operating temperature.)
Q _{gs} Gate-Source Charge	ALL	-	9.0	-	nC	
Q _{gd} Gate-Drain ("Miller") Charge	ALL	-	9.0	-	nC	
L _D Internal Drain Inductance	ALL	-	5.0	-	nH	Measured from the drain lead, 5mm (0.2 in.) from header to center of die.
L _S Internal Source Inductance	ALL	-	15	-	nH	Measured from the source lead, 5mm (0.2 in.) from header to source bonding pad.

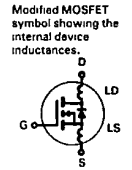

Thermal Resistance

R _{thJC} Junction-to-Case	ALL	-	-	5.0	°C/W	
R _{thJA} Junction-to-Ambient	ALL	-	-	175	°C/W	Free Air Operation

Source-Drain Diode Ratings and Characteristics

I _S Continuous Source Current (Body Diode)	IRFF130 IRFF131	-	-	8.0	A	Modified MOSFET symbol showing the integral reverse P-N junction rectifier.
	IRFF132 IRFF133	-	-	7.0	A	
I _{SM} Pulse Source Current (Body Diode) ③	IRFF130 IRFF131	-	-	32	A	
	IRFF132 IRFF133	-	-	28	A	
V _{SD} Diode Forward Voltage ②	IRFF130 IRFF131	-	-	2.5	V	T _C = 25°C, I _S = 8.0A, V _{GS} = 0V
	IRFF132 IRFF133	-	-	2.3	V	T _C = 25°C, I _S = 7.0A, V _{GS} = 0V
t _{rr} Reverse Recovery Time	ALL	-	300	-	ns	T _J = 150°C, I _F = 8.0A, dI _F /dt = 100A/μs
Q _{RR} Reverse Recovered Charge	ALL	-	1.5	-	μC	T _J = 150°C, I _F = 8.0A, dI _F /dt = 100A/μs
t _{on} Forward Turn on Time	ALL	Intrinsic turn-on time is negligible. Turn-on speed is substantially controlled by L _S + L _D .				

① T_J = 25°C to 150°C. ② Pulse Test: Pulse width < 300μs, Duty Cycle < 2%. ③ Repetitive Rating Pulse width limited by max. junction temperature. See Transient Thermal Impedance Curve (Fig. 5).

IRFF130, IRFF131, IRFF132, IRFF133

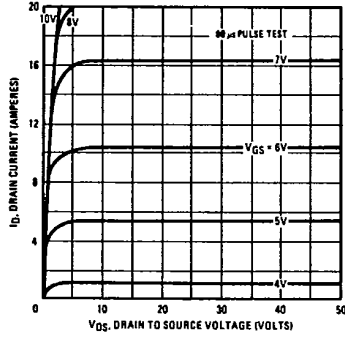

Fig. 1 - Typical Output Characteristics

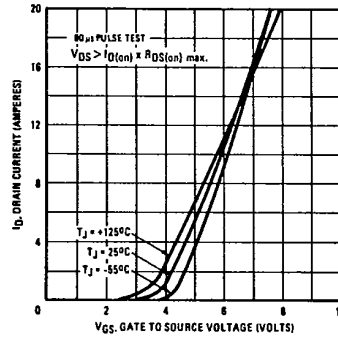

Fig. 2 - Typical Transfer Characteristics

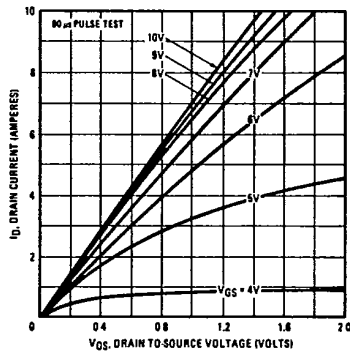

Fig. 3 - Typical Saturation Characteristics

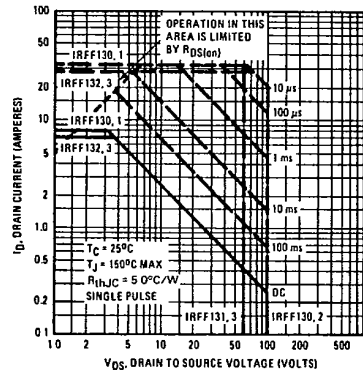

Fig. 4 - Maximum Safe Operating Area

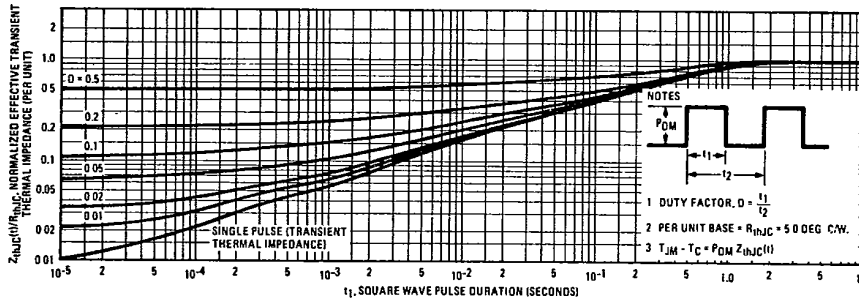

Fig. 5 - Maximum Effective Transient Thermal Impedance, Junction-to-Case Vs. Pulse Duration

IRFF130, IRFF131, IRFF132, IRFF133

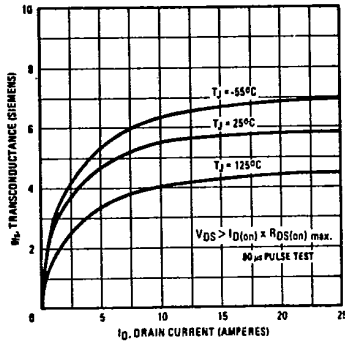

Fig. 6 - Typical Transconductance Vs. Drain Current

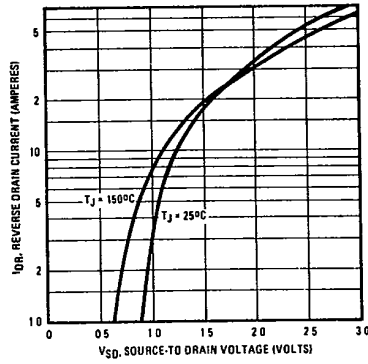

Fig. 7 - Typical Source-Drain Diode Forward Voltage

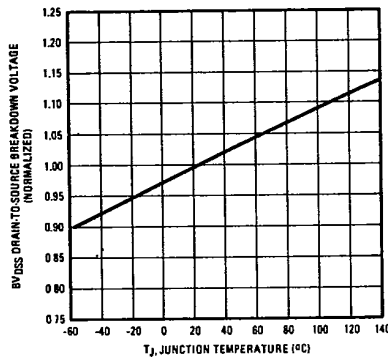

Fig. 8 - Breakdown Voltage Vs. Temperature

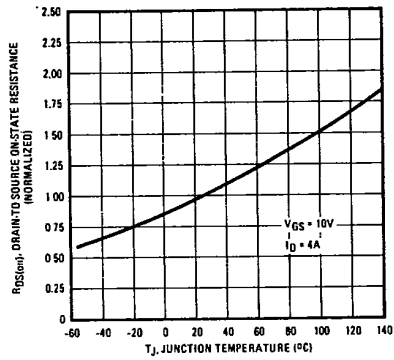

Fig. 9 - Normalized On-Resistance Vs. Temperature

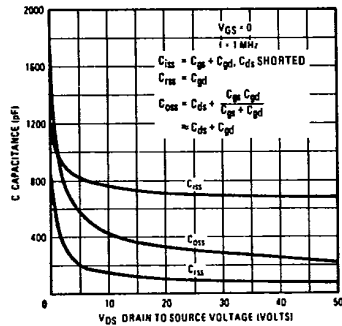

Fig. 10 - Typical Capacitance Vs. Drain-to-Source Voltage

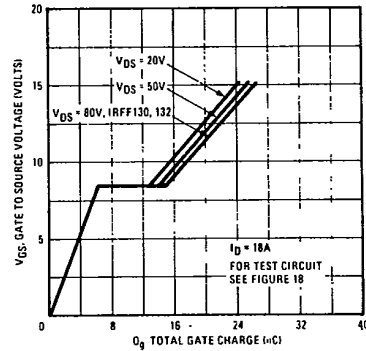

Fig. 11 - Typical Gate Charge Vs. Gate-to-Source Voltage

IRFF130, IRFF131, IRFF132, IRFF133

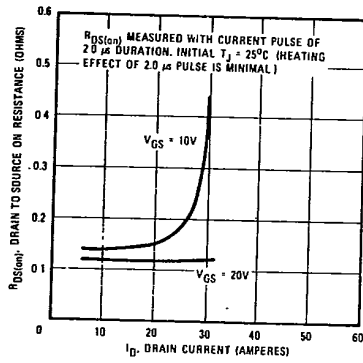

Fig. 12 - Typical On-Resistance Vs. Drain Current

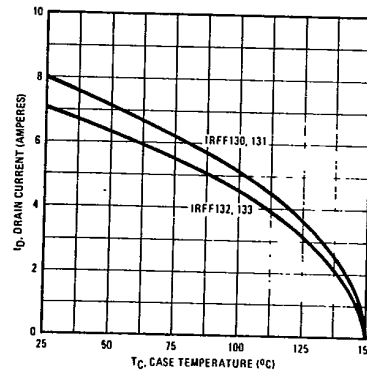

Fig. 13 - Maximum Drain Current Vs. Case Temperature

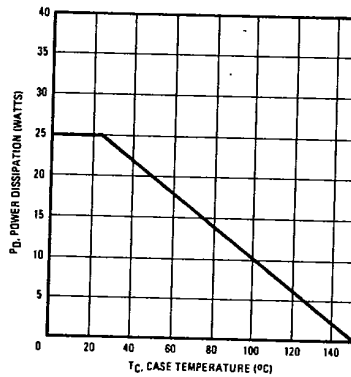

Fig. 14 - Power Vs. Temperature Derating Curve

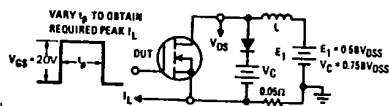

Fig. 15 - Clamped Inductive Test Circuit

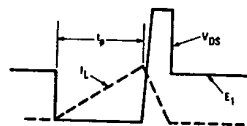

Fig. 16 - Clamped Inductive Waveforms

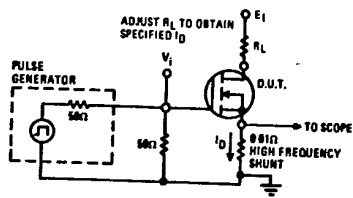

Fig. 17 - Switching Time Test Circuit

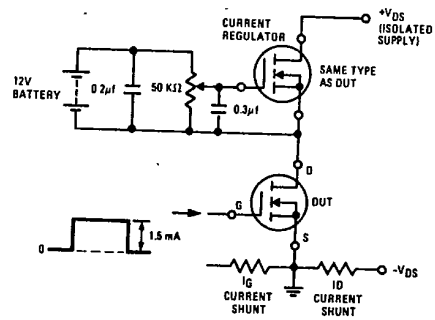

Fig. 18 - Gate Charge Test Circuit