

**BRIGHT RED MSQ6110C, MSQ6140C  
GREEN MSQ6410C, MSQ6440C  
HIGH EFF. RED MSQ6910C, MSQ6940C**

**PACKAGE DIMENSIONS**

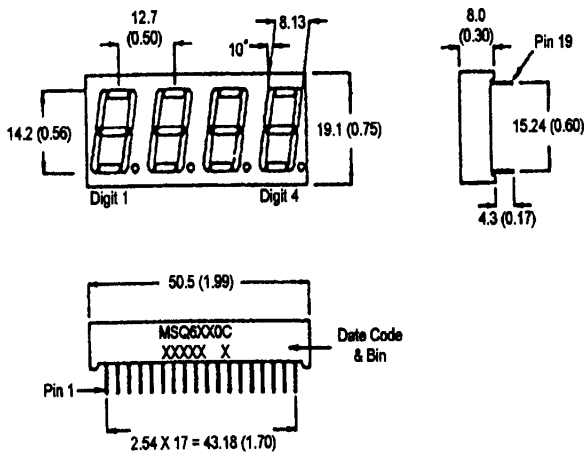

**FEATURES**

- Easy to read digit
- Common anode or cathode
- Low power consumption
- Highly visible bold segments
- High brightness with high contrast
- White segments on a grey face for MSQ64X0C and MSQ61X0C.
- Red segments and red face for MSQ69X0C
- Directly compatible with integrated circuits
- Rugged plastic/epoxy construction

**APPLICATIONS**

- Digital readout displays
- Instrument panels

NOTES: Dimensions are in mm (inch).  
All pins are 0.5 (0.02) diameter  
Tolerances are ± 0.25 (0.1) unless otherwise noted.

**MODEL NUMBERS**

<u>Part number</u>	<u>Color</u>	<u>Description</u>
MSQ6110C	Bright Red	Common Anode; right hand decimal
MSQ6140C	Bright Red	Common Cathode; right hand decimal
MSQ6410C	Green	Common Anode; right hand decimal
MSQ6440C	Green	Common Cathode; right hand decimal
MSQ6910C	High Efficiency Red	Common Anode; right hand decimal
MSQ6940C	High Efficiency Red	Common Cathode; right hand decimal

(For other color options, contact your local area Sales Office)

**ABSOLUTE MAXIMUM RATING** ( $T_A=25^\circ\text{C}$  unless otherwise specified)

	B.Red MSQ 6110C 6140C	Green MSQ 6410C 6440C	High Eff. Red MSQ 6910C 6940C	Unit
Part number				
Continuous forward current ( $I_f$ ) Per Segment	15	30	30	mA
Peak forward current per die ( $I_f$ ) (at $f = 10.0$ KHz, Duty factor = 1/10)	60	90	90	mA
Power dissipation ( $P_D$ )	40*	70*	70*	mW
*Derate Linearly from $25^\circ\text{C}$	0.17	0.33	0.33	mW/ $^\circ\text{C}$
Reverse voltage per dice.....				5V
Operating and Storage temperature range.....				$-25^\circ\text{C}$ to $+85^\circ\text{C}$
Lead soldering time (at 1/16 inch from the bottom of lamp).....				5 seconds @ $230^\circ\text{C}$

**ELECTRO - OPTICAL CHARACTERISTICS** ( $T_A = 25^\circ\text{C}$  unless otherwise specified)

	Bright Red MSQ 6110C 6140C	Green MSQ 6410C 6440C	High Eff. Red MSQ 6910C 6940C	Test Condition
Part number				
Luminous intensity (ucd)				
minimum	300	800	900	$I_f = 20\text{mA}$
typical	700	2200	2200	$I_f = 20\text{mA}$
Forward voltage ( $V_f$ )				
typical	2.1	2.1	2.0	$I_f = 20\text{mA}$
maximum	2.6	2.8	2.8	
Peak wavelength (nm)	697	570	635	$I_f = 20\text{mA}$
Spectral line half width (nm)	90	30	45	$I_f = 20\text{mA}$
Reverse breakdown voltage ( $V_R$ )	5	5	5	$I_R = 100\mu\text{A}$

**PINOUT**

**MSQ6X10C - Common Anode**

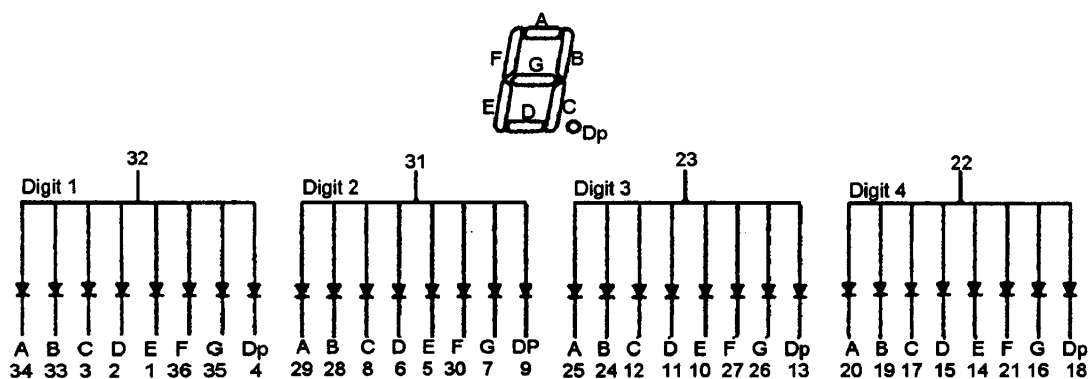

**MSQ6X40C - Common Cathode**

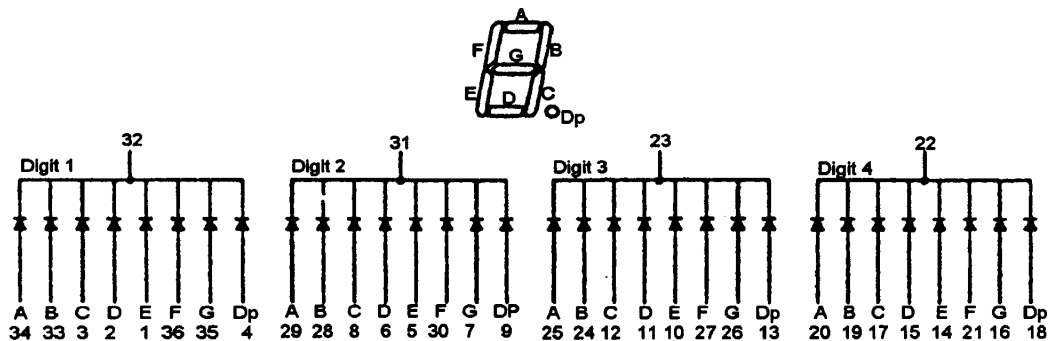

**GRAPHICAL DATA - Bright Red** ( $T_A = 25^\circ\text{C}$  unless otherwise specified)

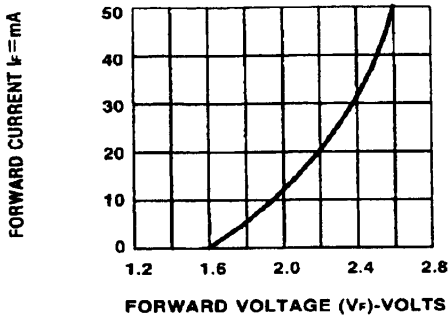

Fig.1 FORWARD CURRENT VS. FORWARD VOLTAGE.

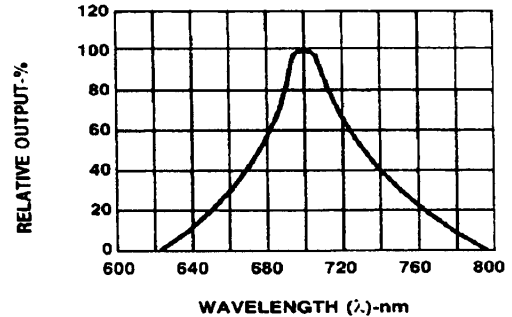

Fig.2 SPECTRAL RESPONSE

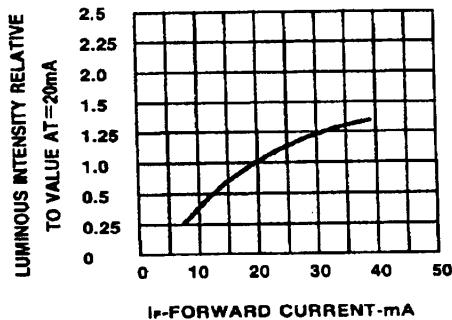

Fig.3 RELATIVE LUMINOUS INTENSITY VS. FORWARD CURRENT

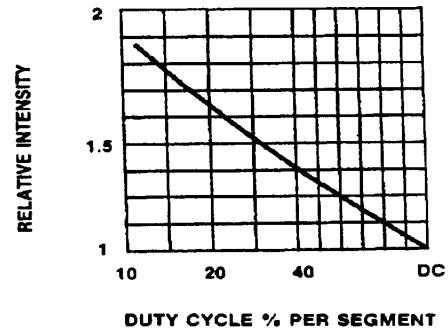

Fig.5 LUMINOUS INTENSITY VS. DUTY CYCLE

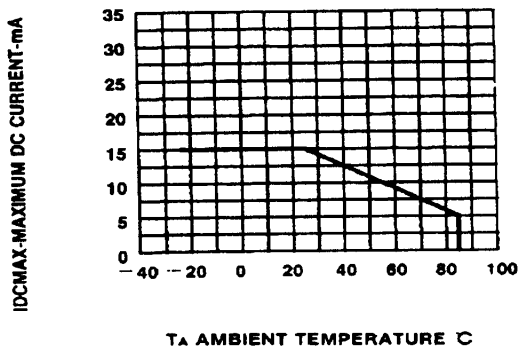

Fig.4 MAXIMUM ALLOWABLE DC CURRENT PER SEGMENT VS. A FUNCTION OF AMBIENT TEMPERATURE.

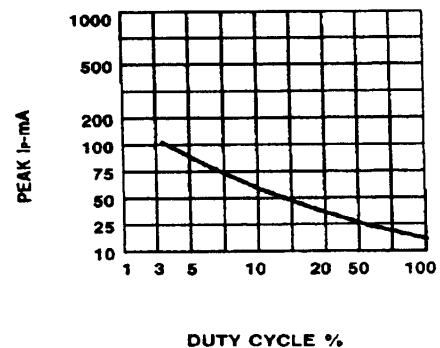
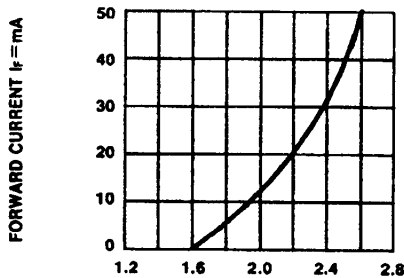
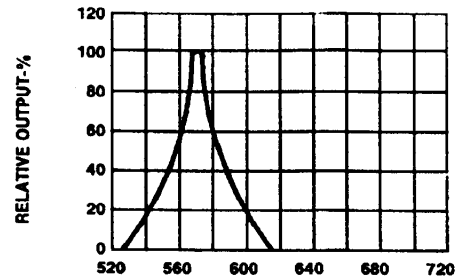

Fig. 6 MAX PEAK CURRENT VS. DUTY CYCLE % (REFRESH RATE  $f=1\text{ KHz}$ )

**GRAPHICAL DATA - Green** ( $T_A = 25^\circ\text{C}$  unless otherwise specified)



**Fig.1 FORWARD CURRENT VS. FORWARD VOLTAGE.**



**Fig.2 SPECTRAL RESPONSE**

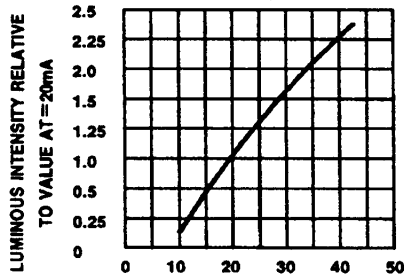

**Fig.3 RELATIVE LUMINOUS INTENSITY VS. FORWARD CURRENT**

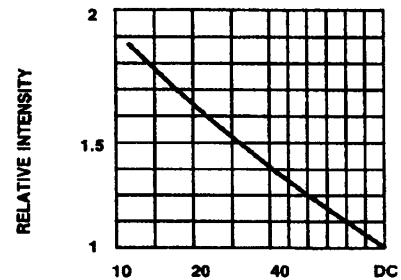

**Fig.5 LUMINOUS INTENSITY VS. DUTY CYCLE**

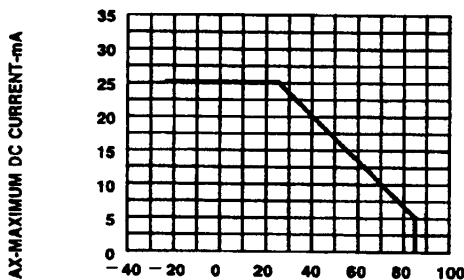

**Fig.4 MAXIMUM ALLOWABLE DC CURRENT PER SEGMENT CS. A FUNCTION OF AMBIENT TEMPERATURE.**

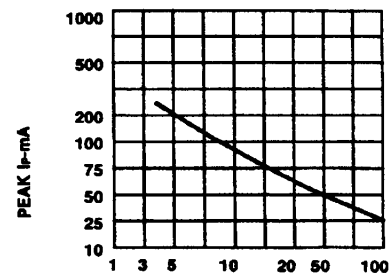

**Fig. 6 MAX PEAK CURRENT VS. DUTY CYCLE % (REFRESH RATE f=1 KHz)**

### GRAPHICAL DATA - High Efficiency Red ( $T_A = 25^\circ\text{C}$ unless otherwise specified)

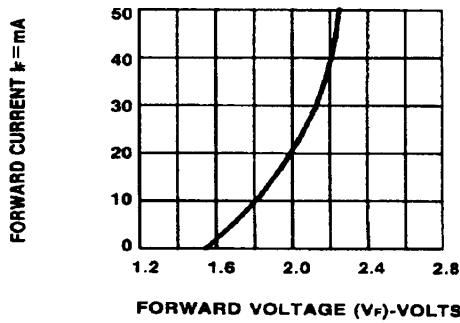

Fig.1 FORWARD CURRENT VS. FORWARD VOLTAGE.

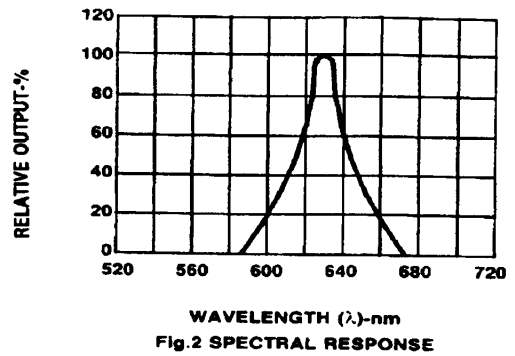

Fig.2 SPECTRAL RESPONSE

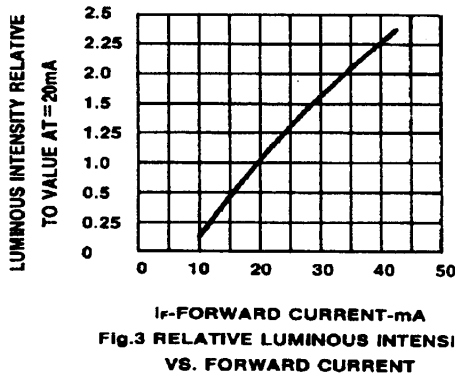

Fig.3 RELATIVE LUMINOUS INTENSITY VS. FORWARD CURRENT

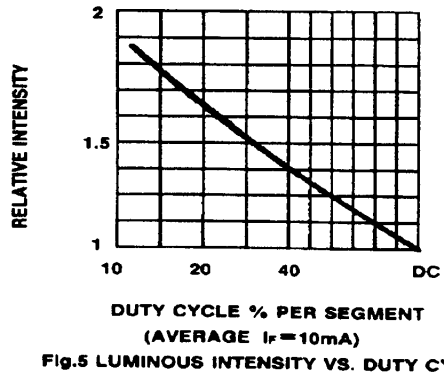

Fig.5 LUMINOUS INTENSITY VS. DUTY CYCLE

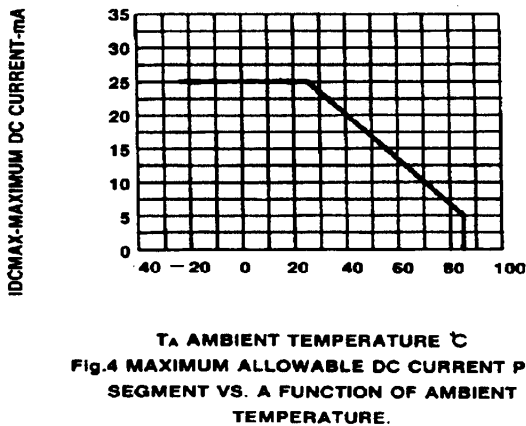

Fig.4 MAXIMUM ALLOWABLE DC CURRENT PER SEGMENT VS. A FUNCTION OF AMBIENT TEMPERATURE.

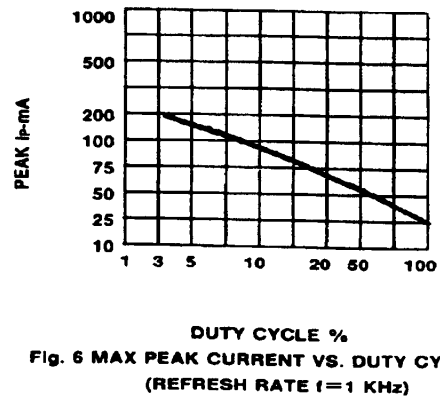

Fig. 6 MAX PEAK CURRENT VS. DUTY CYCLE % (REFRESH RATE  $f = 1\text{ KHz}$ )



**FAIRCHILD**

**SEMICONDUCTOR™**

---

**0.56 INCH (14.2 MM)  
FOUR DIGIT STICK DISPLAY**

**DISCLAIMER**

FAIRCHILD SEMICONDUCTOR RESERVES THE RIGHT TO MAKE CHANGES WITHOUT FURTHER NOTICE TO ANY PRODUCTS HEREIN TO IMPROVE RELIABILITY, FUNCTION OR DESIGN. FAIRCHILD DOES NOT ASSUME ANY LIABILITY ARISING OUT OF THE APPLICATION OR USE OF ANY PRODUCT OR CIRCUIT DESCRIBED HEREIN; NEITHER DOES IT CONVEY ANY LICENSE UNDER ITS PATENT RIGHTS, NOR THE RIGHTS OF OTHERS.

**LIFE SUPPORT POLICY**

FAIRCHILD'S PRODUCTS ARE NOT AUTHORIZED FOR USE AS CRITICAL COMPONENTS IN LIFE SUPPORT DEVICES OR SYSTEMS WITHOUT THE EXPRESS WRITTEN APPROVAL OF THE PRESIDENT OF FAIRCHILD SEMICONDUCTOR CORPORATION. As used herein:

1. Life support devices or systems are devices or systems which, (a) are intended for surgical implant into the body, or (b) support or sustain life, and (c) whose failure to perform when properly used in accordance with instructions for use provided in the labeling, can be reasonably expected to result in a significant injury of the user.
2. A critical component in any component of a life support device or system whose failure to perform can be reasonably expected to cause the failure of the life support device or system, or to affect its safety or effectiveness.