



# High-Gain Instrumentation Operational Amplifier

## OP-06

### FEATURES

- **Very High Voltage Gain** ..... 1,000V/mV Min
- **Low Offset Voltage and Offset Current**
- **Low Drift vs. Temperature**  
(TCV<sub>OS</sub>) ..... 0.8μV/°C Max
- **Low Input Voltage and Current Noise**
- **Low Offset Voltage Drift with Time**
- **High Common-Mode Rejection** ..... 120dB Typ
- **High Power Supply Rejection** ..... 2μV/V Max
- **Wide Supply Range** ..... ±3.0V to ±22V
- **MIL-STD-883 Processing Available**
- **Slew Rate to** ..... 100V/μs
- **Available in Die Form**

### ORDERING INFORMATION<sup>†</sup>

T <sub>A</sub> = 25°C V <sub>OS</sub> MAX (mV)	PACKAGE		OPERATING TEMPERATURE RANGE
	TO-99 8-PIN	CERDIP 8-PIN	
0.2	OP06AJ*	—	MIL
0.5	OP06FJ	—	COM
0.5	OP06BJ	—	MIL
1.3	OP06GJ	OP06GZ	COM

\* For devices processed in total compliance to MIL-STD-883, add /883 after part number. Consult factory for 883 data sheet.

† Burn-in is available on commercial and industrial temperature range parts in cerdip, plastic dip, and TO-can packages.

Superior DC input characteristics include very low offset voltage and current, extremely high open-loop gain, low 1/f and wideband noise, and low "popcorn" noise. Low offset voltage drift is improved by a nulling technique that optimizes TCV<sub>OS</sub> performance when V<sub>OS</sub> is nulled to zero. Very high common-mode and power supply rejection enable accurate performance in noisy environments.

Flexible external compensation provides wide-bandwidth and high slew rate operation in high closed-loop gain applications. Excellent long-term stability, and compatibility with MIL-STD-883 processing, make the OP-06 an excellent choice for high-reliability applications; including strain gauge and thermocouple amplifiers, low-noise audio amplifiers, and instrumentation amplifiers. The OP-06 is a direct replacement for all 725 types providing superior DC and noise performance plus the unique feature of **complete input differential voltage and output short-circuit protection**.

### PIN CONNECTIONS

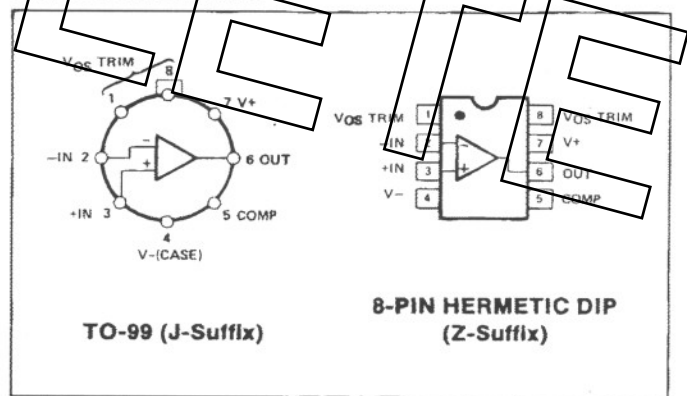

### GENERAL DESCRIPTION

The OP-06 monolithic instrumentation operational amplifier is designed for accurate high-gain amplification of low level signals. High common-mode rejection reduces signal degradation when large common-mode voltages are present.

### SIMPLIFIED SCHEMATIC

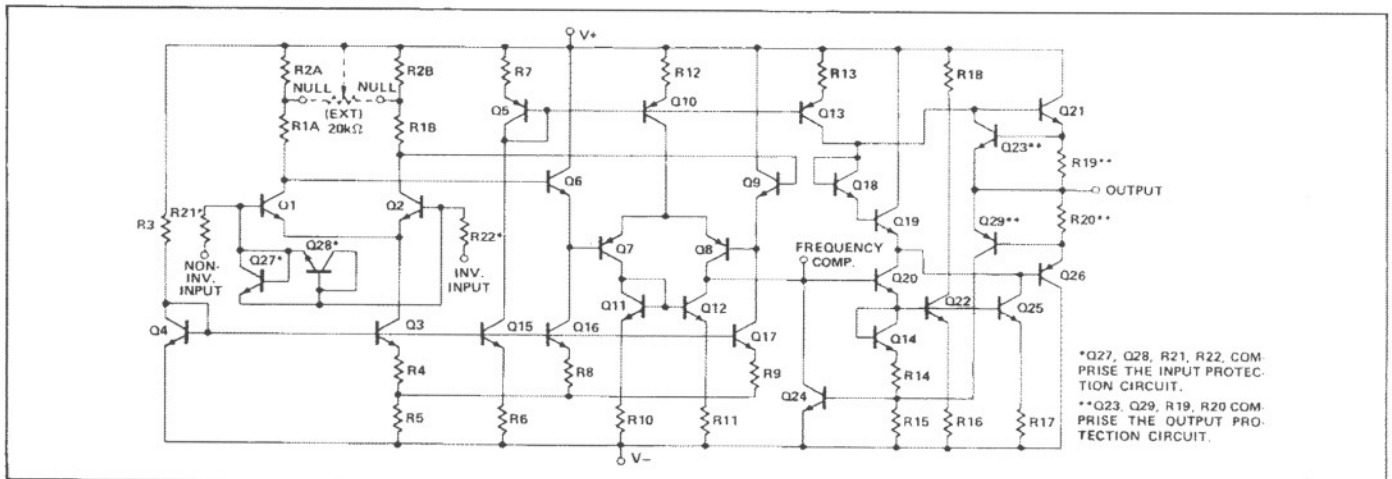

\*Q27, Q28, R21, R22, COM PRISE THE INPUT PROTECTION CIRCUIT.

\*\*Q23, Q29, R19, R20 COM PRISE THE OUTPUT PROTECTION CIRCUIT.

# OP-06

## ABSOLUTE MAXIMUM RATINGS (Note 3)

Supply Voltage	±22V
Differential Input Voltage	±30V
Input Voltage (Note 1)	±22V
Output Short-Circuit Duration	Indefinite
Storage Temperature Range	-65°C to +150°C
Operating Temperature Range	
OP-06A, OP-06B	-55°C to +125°C
OP-06F, OP-06G	0°C to +70°C
Lead Temperature Range (Soldering, 60 sec)	+300°C
Junction Temperature	-65°C to +150°C

PACKAGE TYPE	$\theta_{JA}$ (NOTE 2)	$\theta_{JC}$	UNITS
TO-99 (J)	150	18	°C/W
8-Pin Hermetic DIP (Z)	148	16	°C/W

### NOTES:

- For supply voltages less than ±22V, the absolute maximum input voltage is equal to the supply voltage.
- $\theta_{JA}$  is specified for worst case mounting conditions, i.e.,  $\theta_{JA}$  is specified for device in socket for TO and CerDIP packages.
- Absolute ratings apply to both DICE and packaged parts, unless otherwise noted.

## ELECTRICAL CHARACTERISTICS at $V_S = \pm 15V$ , $T_A = 25^\circ C$ , unless otherwise noted.

PARAMETER	SYMBOL	CONDITIONS	OP-06A			OP-06B/F			OP-06G			UNITS
			MIN	TYP	MAX	MIN	TYP	MAX	MIN	TYP	MAX	
Input Offset Voltage	$V_{OS}$	$R_S \leq 20k\Omega$ (Note 2)	—	0.06	0.2	—	0.2	0.5	—	0.4	1.3	mV
Input Offset Current	$I_{OS}$		—	0.3	2.0	—	0.75	5.0	—	2	13	nA
Input Bias Current	$I_B$		—	30	70	—	30	80	—	40	110	nA
Input Noise Voltage Density	$e_n$	$f_O = 10\text{Hz}$ (Note 1)	—	9.0	15.0	—	9.0	15.0	—	9.0	15.0	nV/ $\sqrt{\text{Hz}}$
		$f_O = 100\text{Hz}$ (Note 1)	—	8.0	9.0	—	8.0	9.0	—	8.0	9.0	
		$f_O = 1000\text{Hz}$ (Note 1)	—	7.0	7.5	—	7.0	7.5	—	7.0	7.5	
Input Noise Current Density	$i_n$	$f_O = 10\text{Hz}$ (Note 1)	—	0.5	1.2	—	0.5	1.2	—	0.6	1.4	pA/ $\sqrt{\text{Hz}}$
		$f_O = 100\text{Hz}$ (Note 1)	—	0.25	0.6	—	0.25	0.6	—	0.3	0.7	
		$f_O = 1000\text{Hz}$ (Note 1)	—	0.15	0.25	—	0.15	0.25	—	0.2	0.3	
Input Resistance	$R_{IN}$	(Note 3)	0.5	1.8	—	0.7	1.8	—	0.5	1.5	—	M $\Omega$
Large-Signal Voltage Gain	$A_{VO}$	$R_L \geq 2k\Omega$ , $V_O = \pm 10V$	1,000	3,000	—	1,000	3,000	—	500	3,000	—	V/mV
Output Voltage Swing	$V_O$	$R_L \geq 10k\Omega$	±12.5	±13.0	—	±12.5	±13.0	—	±12.0	±13.0	—	V
		$R_L \geq 2k\Omega$	±12.0	±12.8	—	±12.0	±12.8	—	±11.5	±12.8	—	V
		$R_L \geq 1k\Omega$	±11.0	±12.5	—	±11.0	±12.5	—	±12.0	—	—	V
Input Voltage Range	IVR		±13.5	±14.0	—	±13.5	±14.0	—	±13.5	±14.0	—	V
Common-Mode Rejection Ratio	CMRR	$V_{CM} = \pm 13.5V$ $R_S \leq 20k\Omega$	114	120	—	114	120	—	110	115	—	dB
Power Supply Rejection Ratio	PSRR	$V_S = \pm 3V$ to $\pm 18V$ $R_S \leq 20k\Omega$	—	0.5	2.0	—	1.0	5.0	—	2.0	10	$\mu V/V$
Power Consumption	$P_d$		—	90	120	—	90	120	—	110	150	mW
Large-Signal Voltage Gain	$A_{VO}$	$R_L \geq 500\Omega$ , (Note 3) $V_O = \pm 0.5V$ $V_S = \pm 3V$	100	600	—	100	600	—	60	600	—	V/mV
Power Consumption	$P_d$	$V_S = \pm 3V$	—	4	6	—	4	6	—	4	8	mW

### NOTES:

- Sample tested.
- Thermoelectric voltages generated by dissimilar metals at the contacts to the input terminals can degrade drift performance. Both sides of the contacts should be kept at approximately the same temperature. All temperature gradients should be minimized.
- Guaranteed by design.

**ELECTRICAL CHARACTERISTICS** at  $V_S = \pm 15V$ ,  $-55^\circ C \leq T_A \leq +125^\circ C$ , unless otherwise noted.

PARAMETER	SYMBOL	CONDITIONS	OP-06A			OP-06B			UNITS
			MIN	TYP	MAX	MIN	TYP	MAX	
Input Offset Voltage (Without external trim)	$V_{OS}$	$R_S \leq 20k\Omega$ (Note 2)	—	0.08	0.28	—	0.3	0.7	mV
Average Input Offset Voltage Drift (Without external trim)	$TCV_{OS}$	$R_S = 50\Omega$ (Notes 1, 2)	—	0.3	0.8	—	0.7	2.0	$\mu V/^\circ C$
Average Input Offset Voltage Drift (With external trim)	$TCV_{OSn}$	$R_S = 50\Omega$ (Notes 2, 3) $R_P = 20k\Omega$	—	0.2	0.6	—	0.28	1.0	$\mu V/^\circ C$
Input Offset Current	$I_{OS}$	$T_A$ MAX $T_A$ MIN	—	0.25 0.8	1.0 4.0	—	0.6 2.0	4.0 18.0	nA
Average Input Offset Current Drift	$TCI_{OS}$	(Note 1)	—	3	20	—	8	90	$\mu A/^\circ C$
Input Bias Current	$I_B$	$T_A$ MAX $T_A$ MIN	—	22 40	60 120	—	25 45	70 180	nA
Common-Mode Rejection Ratio	CMRR	$V_{CM} = \pm 13.5V$ $R_S \leq 20k\Omega$	109	112	—	109	112	—	dB
Power Supply Rejection Ratio	PSRR	$V_S = \pm 3V$ to $\pm 18V$ $R_S \leq 20k\Omega$	—	1	5	—	2	8	$\mu V/V$
Large-Signal Voltage Gain	$A_{VO}$	$V_O = \pm 10V$ ; $R_L \geq 2k\Omega$ $T_A$ MAX $T_A$ MIN	1,000 800	3,500 1,800	—	1,000 700	3,500 1,800	—	V/mV
Output Voltage Swing	$V_O$	$R_L \geq 2k\Omega$	$\pm 12.0$	$\pm 12.6$	—	$\pm 12.0$	$\pm 12.6$	—	V

**ELECTRICAL CHARACTERISTICS** at  $V_S = \pm 15V$ ,  $0^\circ C \leq T_A \leq 70^\circ C$ , unless otherwise noted.

PARAMETER	SYMBOL	CONDITIONS	OP-06F			OP-06G			UNITS
			MIN	TYP	MAX	MIN	TYP	MAX	
Input Offset Voltage (Without external trim)	$V_{OS}$	$R_S \leq 20k\Omega$ (Note 2)	—	0.25	0.6	—	0.5	1.6	mV
Average Input Offset Voltage Drift (Without external trim)	$TCV_{OS}$	$R_S = 50\Omega$ (Notes 1, 2)	—	0.7	2.0	—	1.4	4.5	$\mu V/^\circ C$
Average Input Offset Voltage Drift (With external trim)	$TCV_{OSn}$	$R_S = 50\Omega$ (Notes 2, 3) $R_P = 20k\Omega$	—	0.28	1.0	—	0.5	1.5	$\mu V/^\circ C$
Input Offset Current	$I_{OS}$	$T_A$ MAX $T_A$ MIN	—	0.65 2.0	5.0 18.0	—	2.0 3.0	15 25	nA
Average Input Offset Current Drift	$TCI_{OS}$	(Note 1)	—	8	90	—	14	150	$\mu A/^\circ C$
Input Bias Current	$I_B$	$T_A$ MAX $T_A$ MIN	—	30 45	80 180	—	35 45	110 180	nA
Common-Mode Rejection Ratio	CMRR	$V_{CM} = \pm 13.5V$ $R_S \leq 20k\Omega$	109	112	—	95	110	—	dB
Power Supply Rejection Ratio	PSRR	$V_S = \pm 3V$ to $\pm 18V$ $R_S \leq 20k\Omega$	—	1.5	7.0	—	3.0	15	$\mu V/V$
Large-Signal Voltage Gain	$A_{VO}$	$V_O = \pm 10V$ ; $R_L \geq 2k\Omega$ $T_A$ MAX $T_A$ MIN	1,000 800	3,500 1,800	—	400 300	3,200 1,700	—	V/mV
Output Voltage Swing	$V_O$	$R_L \geq 2k\Omega$	$\pm 12.0$	$\pm 12.6$	—	$\pm 11.0$	$\pm 12.6$	—	V

**NOTES:**

1. Sample tested.
2. Thermoelectric voltages generated by dissimilar metals at the contacts to the input terminals can degrade drift performance. Both sides of the

- contacts should be kept at approximately the same temperature. All temperature gradients should be minimized.
3. Guaranteed by input bias current.

# OP-06

## DICE CHARACTERISTICS

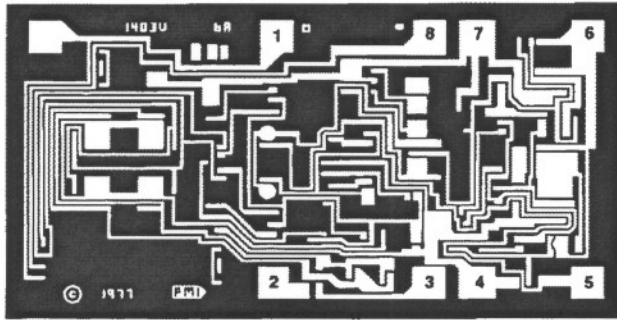

1. NULL
2. INVERTING INPUT
3. NONINVERTING INPUT
4. V-
5. COMPENSATION
6. OUTPUT
7. V+
8. NULL

DIE SIZE 0.095 × 0.051 inch, 4845 sq. mils  
(2.41 × 1.30 mm, 3.13 sq. mm)

**WAFER TEST LIMITS** at  $V_S = \pm 15V$ ,  $T_A = 25^\circ C$  for OP-06N, OP-06G and OP-06GR devices;  $T_A = 125^\circ C$  for OP-06NT and OP-06GT devices, unless otherwise noted. (Note 2)

PARAMETER	SYMBOL	CONDITIONS	OP-06NT LIMIT	OP-06N LIMIT	OP-06GT LIMIT	OP-06G LIMIT	OP-06GR LIMIT	UNITS
Input Offset Voltage	$V_{OS}$	$R_S \leq 20k\Omega$	0.3	0.2	0.7	0.5	1.3	mV MAX
Input Offset Current	$I_{OS}$		1	2	4	5	13	nA MAX
Input Bias Current	$I_B$		60	70	70	80	110	nA MAX
Input Resistance Differential Mode	$R_{IN}$	(Note 1)	—	0.8	—	0.7	0.5	MΩ MIN
Input Voltage Range	IVR		$\pm 13.0$	$\pm 13.5$	$\pm 13.0$	$\pm 13.5$	$\pm 13.5$	V MIN
Common-Mode Rejection Ratio	CMRR	$V_{CM} = \pm 13.5$ $R_S \leq 20k\Omega$	108	114	108	114	110	dB MIN
Power Supply Rejection Ratio	PSRR	$V_S = \pm 3V$ to $\pm 18V$ $R_S \leq 20k\Omega$	6	2	8	5	10	$\mu V/V$ MAX
Output Voltage Swing	$V_O$	$R_L \geq 10k\Omega$ $R_L \geq 2k\Omega$ $R_L \geq 1k\Omega$	— $\pm 12.0$ —	$\pm 12.5$ $\pm 12.0$ $\pm 11.0$	— $\pm 12.0$ —	$\pm 12.5$ $\pm 12.0$ $\pm 11.0$	$\pm 12.0$ $\pm 11.5$ —	V MIN
Large-Signal Voltage Gain	$A_{VO}$	$R_L \geq 2k\Omega$ $V_O = \pm 10V$	1000	1000	800	1000	500	V/mV MIN
Differential Input Voltage			$\pm 30$	$\pm 30$	$\pm 30$	$\pm 30$	$\pm 30$	V MAX
Power Consumption ( $V_{OUT} = 0V$ )	$P_d$		—	120	—	120	150	mW MAX

**NOTE:**

Electrical tests are performed at wafer probe to the limits shown. Due to variations in assembly methods and normal yield loss, yield after packaging is not guaranteed for standard product dice. Consult factory to negotiate specifications based on dice lot qualification through sample lot assembly and testing.

**TYPICAL ELECTRICAL CHARACTERISTICS** at  $V_S = \pm 15V$ ,  $T_A = +25^\circ C$ , unless otherwise noted.

PARAMETER	SYMBOL	CONDITIONS	OP-06NT TYPICAL	OP-06N TYPICAL	OP-06GT TYPICAL	OP-06G TYPICAL	OP-06GR TYPICAL	UNITS
Average Input Offset Voltage Drift	$TCV_{OS}$	$R_S \leq 50\Omega$	0.3	0.3	0.7	0.7	1.4	$\mu V/^\circ C$
Nullled Input Offset Voltage Drift	$TCV_{OSn}$	$R_S \leq 50k\Omega$ $R_P = 20k\Omega$	0.2	0.2	0.28	0.28	0.5	$\mu V/^\circ C$
Average Input Offset Current Drift	$TCI_{OS}$		3	3	8	8	14	pA/^\circ C

**NOTES:**

1. Guaranteed by input bias current.
2. For  $+25^\circ C$  specifications of OP-06NT and OP-06GT, see OP-06N and OP-06G respectively.

TYPICAL PERFORMANCE CHARACTERISTICS

OPEN-LOOP RESPONSE FOR VALUES OF COMPENSATION

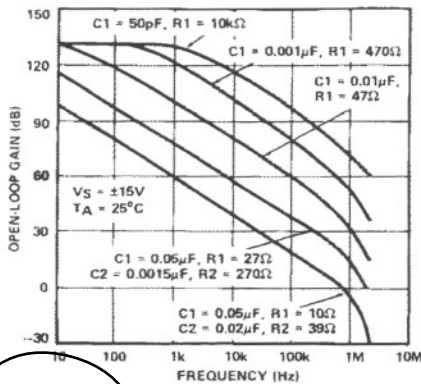

SLEW RATE USING RECOMMENDED COMPENSATION NETWORKS

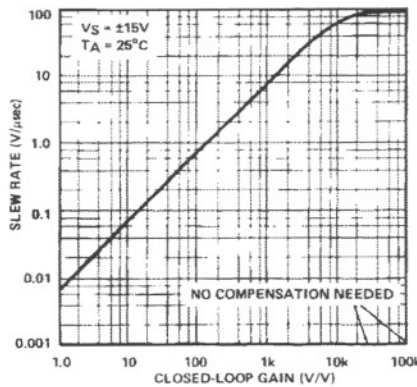

CLOSED-LOOP FREQUENCY RESPONSE FOR VALUES OF COMPENSATION

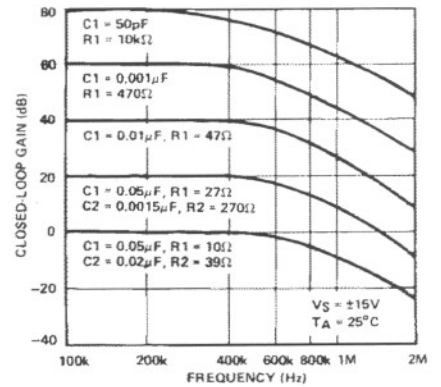

FREQUENCY COMPENSATION  
COMPENSATION VALUES

$A_{vcl}$	$R_1$ ( $\Omega$ )	$C_1$ ( $\mu F$ )	$R_2$ ( $\Omega$ )	$C_2$ ( $\mu F$ )
10000	10k	50pF	—	—
1000	470	0.001	—	—
100	47	0.01	—	—
10	27	0.05	270	0.0015
1	10	0.05	39	0.02

COMPENSATION CIRCUIT (J or Z PACKAGE)

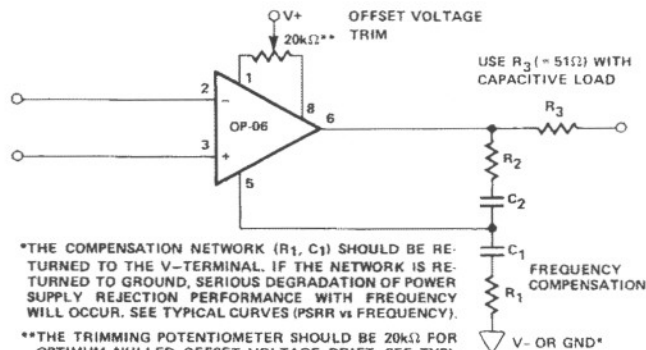

\*THE COMPENSATION NETWORK ( $R_1, C_1$ ) SHOULD BE RETURNED TO THE V-TERMINAL. IF THE NETWORK IS RETURNED TO GROUND, SERIOUS DEGRADATION OF POWER SUPPLY REJECTION PERFORMANCE WITH FREQUENCY WILL OCCUR. SEE TYPICAL CURVES (PSRR vs FREQUENCY).

\*\*THE TRIMMING POTENTIOMETER SHOULD BE 20k $\Omega$  FOR OPTIMUM NULLED OFFSET VOLTAGE DRIFT. SEE TYPICAL CURVES (TRIMMED OFFSET VOLTAGE DRIFT AS A FUNCTION OF TRIMMING POTENTIOMETER).



# OP-06

## TYPICAL PERFORMANCE CHARACTERISTICS

**TRIMMED OFFSET VOLTAGE vs TEMPERATURE**

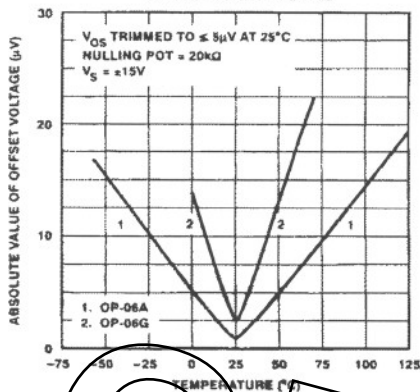

**OFFSET VOLTAGE vs TEMPERATURE**

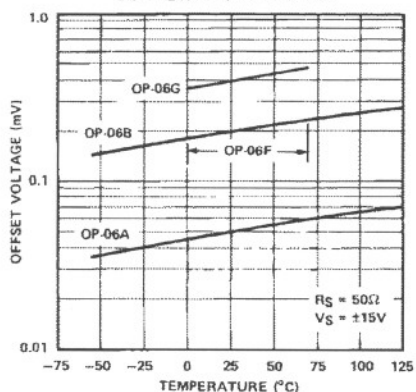

**OFFSET VOLTAGE DRIFT WITH TIME**

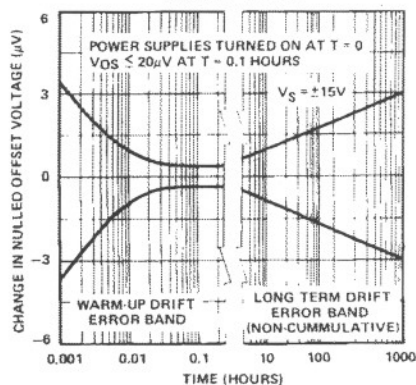

**TRIMMED OFFSET VOLTAGE DRIFT AS A FUNCTION OF TRIMMING POTENTIOMETER (Rp) SIZE AND VOS**

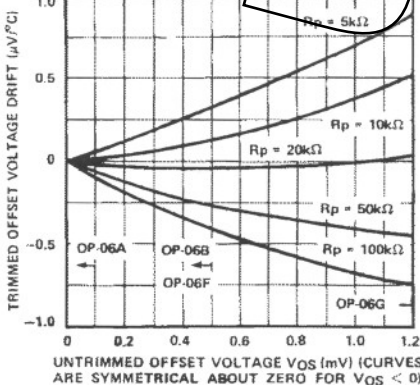

**OFFSET CURRENT vs TEMPERATURE**

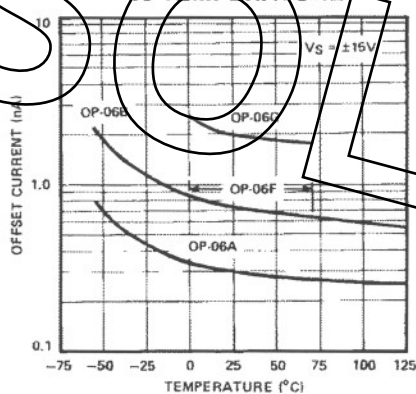

**INPUT BIAS CURRENT vs TEMPERATURE**

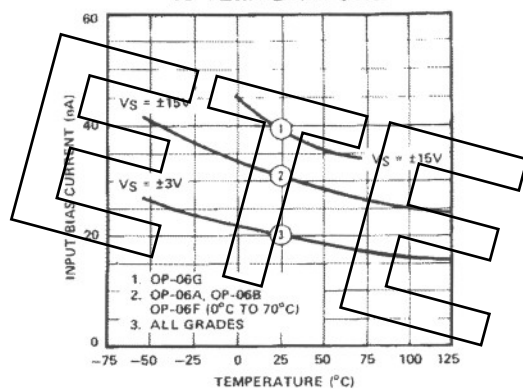

**CMRR vs FREQUENCY**

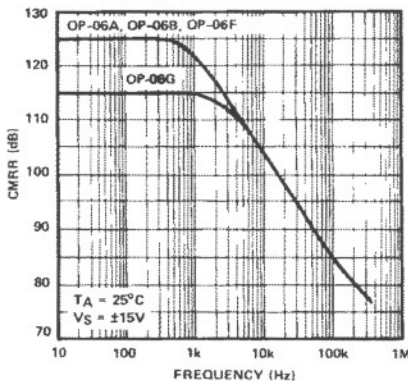

**PSRR vs FREQUENCY (OP-06B, OP-06E)**

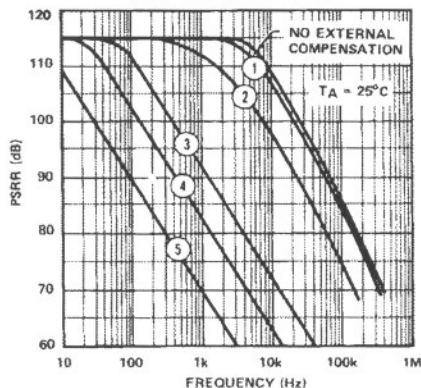

**MAXIMUM OUTPUT VOLTAGE vs LOAD RESISTANCE**

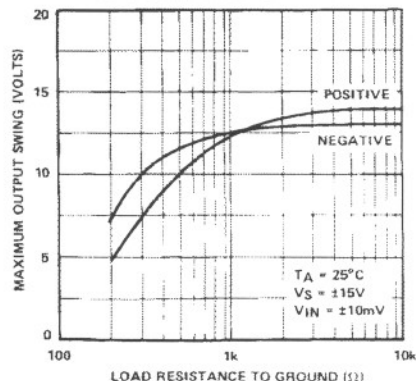

1. C1 = 0.001µF, R1 = 470Ω FROM PIN 5 TO V-
2. C1 = 0.1µF, R1 = 5Ω TO V-
3. C1 = 0.001µF, R1 = 470Ω FROM PIN 5 TO GND
4. C1 = 0.05µF, R1 = 10Ω, C2 = 0.02µF, R2 = 39Ω TO V-
5. C1 = 0.05µF, R1 = 10Ω, C2 = 0.02µF, R2 = 39Ω TO GND

TYPICAL PERFORMANCE CHARACTERISTICS

VOLTAGE NOISE DENSITY vs FREQUENCY

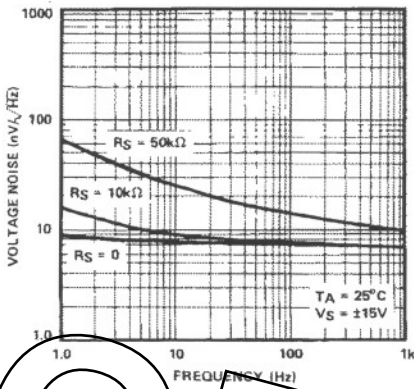

INPUT WIDEBAND NOISE vs BANDWIDTH

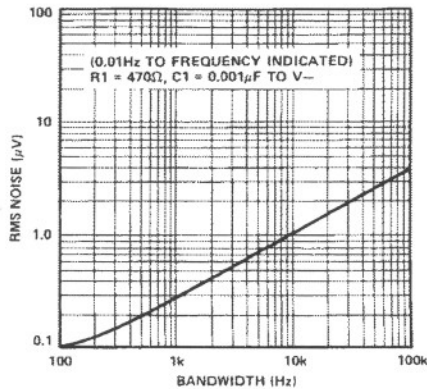

NOISE FIGURE vs SOURCE RESISTANCE

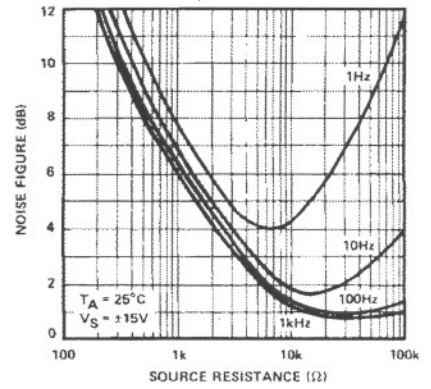

OPEN-LOOP GAIN vs TEMPERATURE

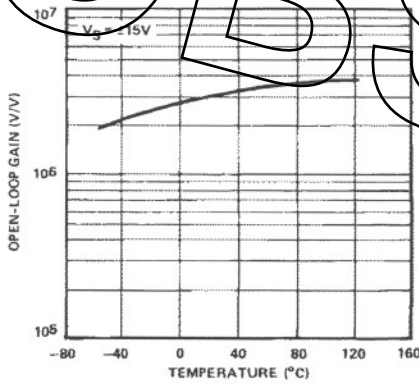

OPEN-LOOP GAIN vs SUPPLY VOLTAGE

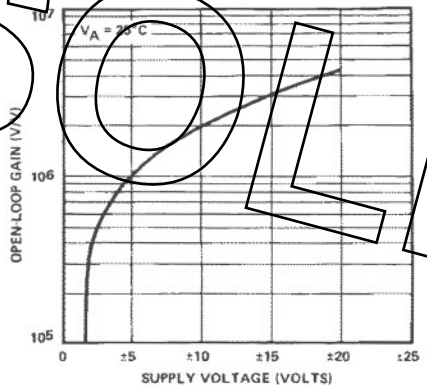

MAXIMUM OUTPUT SWING vs FREQUENCY

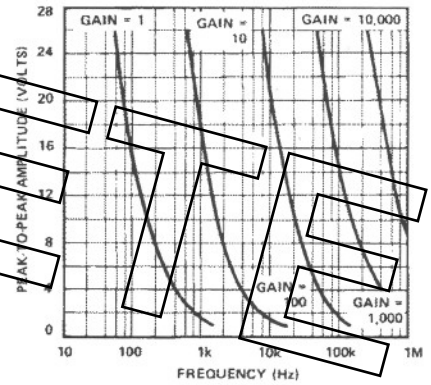

INPUT BIAS CURRENT vs DIFFERENTIAL INPUT VOLTAGE

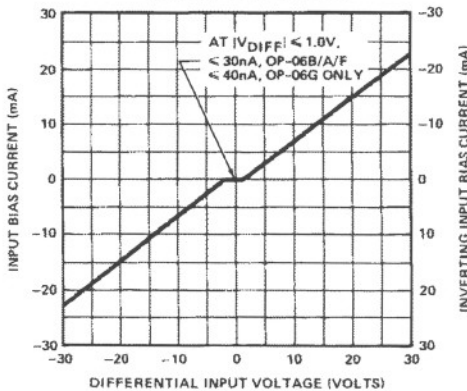

POWER CONSUMPTION vs SUPPLY VOLTAGE

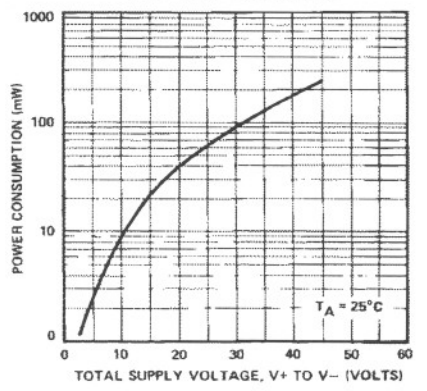

OUTPUT SHORT-CIRCUIT CURRENT

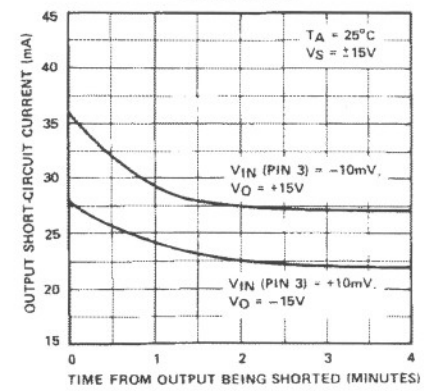

OBSOLETE

# OP-06

## GUARANTEED PERFORMANCE CHARACTERISTICS

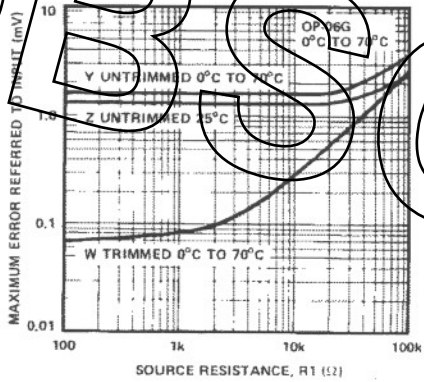
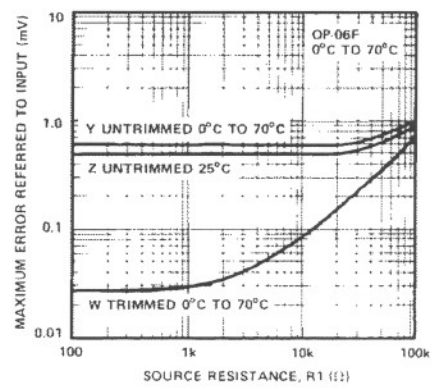
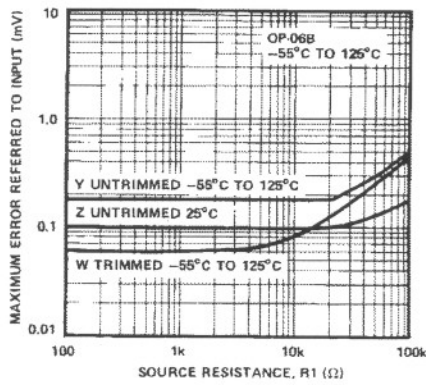
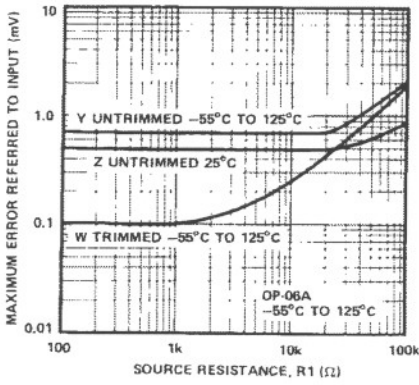

These graphs depict maximum error referred to the input as a function of source resistance (R<sub>1</sub>). Curves W are shown with V<sub>OS</sub> trimmed at +25°C and include errors due to V<sub>OS</sub> and I<sub>OS</sub> over the indicated temperature range. Curves Y and Z plot maximum errors with V<sub>OS</sub> not trimmed.